

Original manual  
DK/SE/DE/EN

---

**P.Lindberg**

9058174

SS-404



[www.p-lindberg.dk](http://www.p-lindberg.dk)  
[www.p-lindberg.no](http://www.p-lindberg.no)  
[www.p-lindberg.se](http://www.p-lindberg.se)  
[www.p-lindberg.de](http://www.p-lindberg.de)



DK

Original

Brugsanvisning



Varenr.: 9058174

Læskur t. dyrehold  
4x4x3,15 meter



Sdr. Ringvej 1 - 6600 Vejen - Tlf. 70 21 26 26 - Fax 70 21 26 30  
[www.p-lindberg.dk](http://www.p-lindberg.dk)

## Læskur til dyrehold - Varenr. 9058174

**Beskrivelse:** Telt med galvaniseret stål-stel og PVC teltdug. B x L4 x H3,15 meter.

**Anvendelsesområder:** Til opbevaring af gods / maskiner, samt som læskur til dyrehold for beskyttelse mod vind & vejr, insekter, sol m.v.

### Sikkerhedsinstruktioner:

Læs hele denne manual før læskuret samles. Det er meget vigtigt at læskuret forankres forsvarligt. Læskuret er kun tiltænkt som midlertidig indretning og det anbefales ikke at bruge det som en permanent indretning.

### Fare:

Vælg læskurets placering med omhu.

#### Hold god afstand til elkabler.

Tjek for overhængende forsyningsledninger, grene og andet.

Tjek undergrunden for ledninger og rør før gravning påbegyndes.

Placer ikke læskuret tæt på tagudhæng eller andre indretninger, hvorfra der kan falde sne, is eller strømme vand ned på læskuret.

Hæng ikke genstande op i loftet eller støttekabler.



### Advarsel:

Brandrisiko.

Ryg ikke og brug ikke udstyr med åbne flammer (inkl. grill, ildsted, frituregryde, rygeovne og lanterner) i eller rundt om læskuret.

Opbevar ikke brændbare væsker / gasser (som benzin, petroleum, propan etc.) i eller omkring læskuret.

Udsæt ikke læskurets tag eller sider på læskuret for åben ild eller andre flammekilder.



### Pas på:

Pas på når stellet rejses. Brug sikkerhedsbriller. Fastgør og bolt overliggende stænger sammen. Pas på stængernes ender.

### Korrekt forankring og montering af stellet:

***Det er slutbrugerens ansvar at forankre stellet ordentligt.***

Sælger er ikke ansvarlig for skade på enheden eller indholdet som følge af vejrliget. Ethvert læskur, som ikke er sikkert forankret kan potentielt flyve væk og forårsage

skade, som ikke vil blive dækket af garantien. Tjek jævnligt ankrene for at sikre læskurets stabilitet.

Bemærk: Teltdugen kan hurtigt fjernes og opbevares forud for dårligt vejr. Hvis stærk vind eller dårligt vejr forudsiges, anbefales det at fjerne teltdugen.

### **Rengøring / vedligeholdelse:**

En stramtsiddende teltdug sikrer længere levetid og bedre funktion. Hold derfor altid teltdugen stram. Løst stof kan fremskynde nedbrydningen af dugen.

Fjern straks sne eller is, som har samlet sig fra tagkonstruktionen med en kost, moppe eller andet redskab med bløde sider. Vær ekstremt påpasselig, når der fjernes sne fra teltdugen – fjern det altid fra ydersiderne af konstruktionen. Brug ikke værktøj eller redskaber med hårde kanter såsom river og skovle for at fjerne sne. Det vil kunne lave huller i teltdugen.



Brug ikke blegemiddel eller stærke, slibende produkter til at rengøre teltdugen med. Teltdugen rengøres let med mild sæbe og vand.











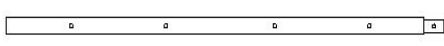
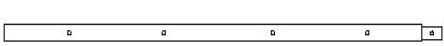
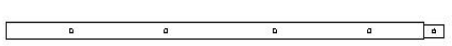

### **Før ibrugtagning:**



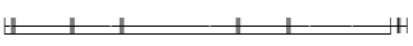

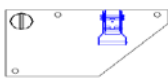

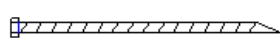
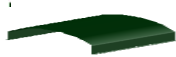
Det anbefales at være 2+ personer om at samle læskuret.

### **Nødvendigt værktøj til samling:**

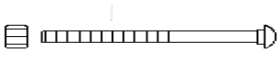

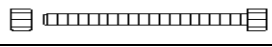
## Komponentliste

Nr	Beskrivelse		Stk.	Box
1	Bøjet top tværbjælke		3	A
2	Bøjet tværbjælke til sidevæg		6	A
3	Stolpe til endegavl (venstre)		1	A
4	Stolpe til endegavl (højre)		1	A
5	Stolper til forgavl		2	A
6	Stolper til midterbuen		2	A
7	Taglægter		10	A
8	Hegn til sidevæg		8	A
9	Nederste midterportal til endegavl		1	A
10	Øverste midterportal til endegavl		1	A
11	Hegn til endegavl		4	A
12	Stolpefødder til hjørner		4	A
13	Stolpefødder til midterbuen		2	A
14	Stolpefødder til endegavl		1	A
15	Pæleplækker		22	A
16	Teldug, tag		1	A
18	Teldug, endegavl		1	A
19	Reb til teltdug, tag og endegavl		20m	A

20	Bræddebolt M8x70 til taglægter (7) og yderside af hegn		33+4	A
21	Bolt M8x60 til tværbjælker		48+6	A
22	Bolt M8x70 til inderside af hegn		12+4	A
23	Bolt M10x30 til portal (10)		1+1	A
24	Kabelbindere til fastgørelse at endegavl		36	A
25	Vinkelbeslag til portal (10)		1	A

## Opstilling af stel

### Trin 1: Stolpefødder og pælepløkker

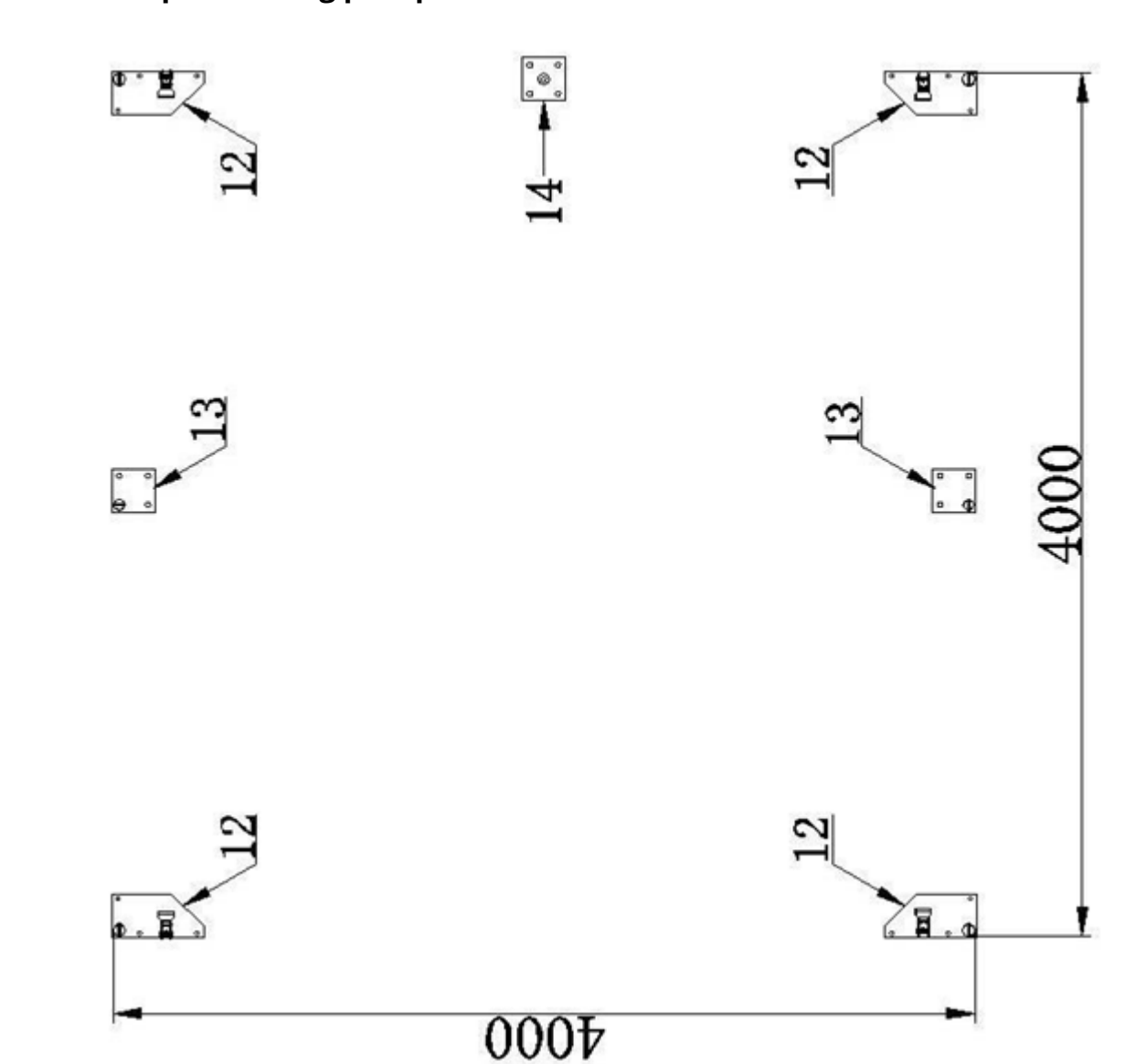



**Trin 2: Første bue (frontgavlen)**

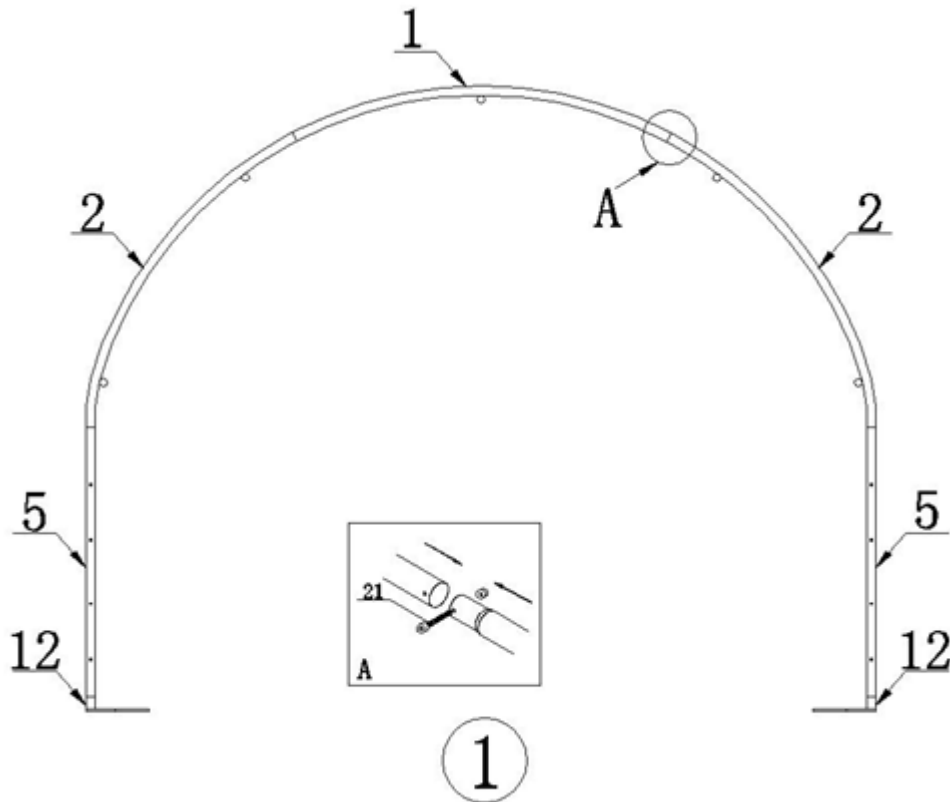

**Trin 3: Anden bue (midterbuen)**

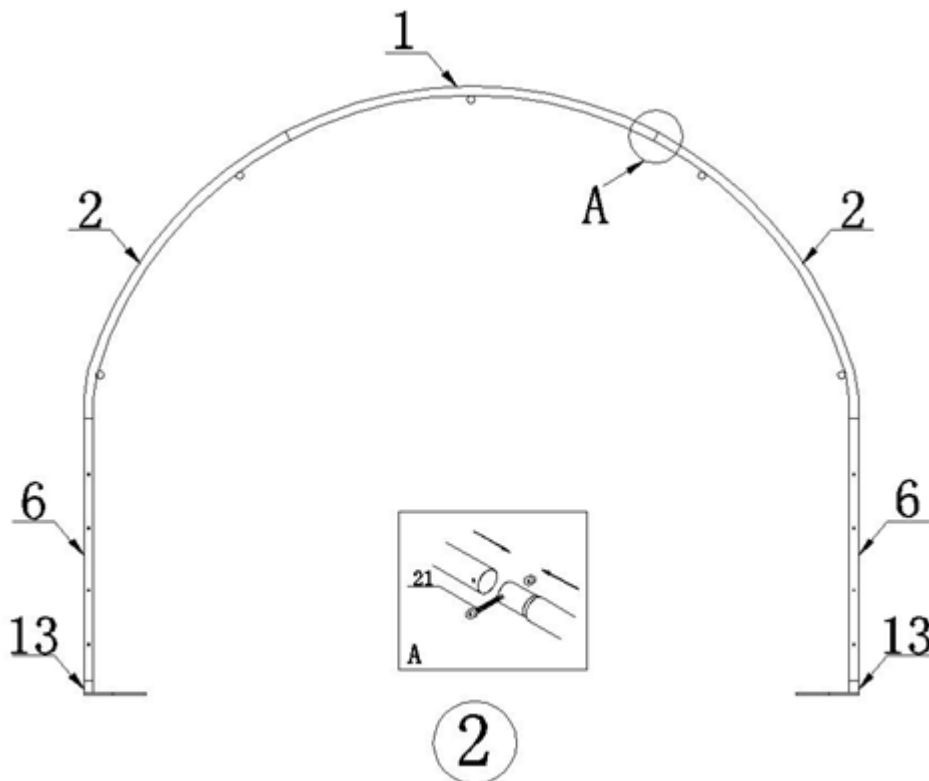



**Trin 6: Opretning af stellet og fastgørelse af stolpefødderne med pæleplækker**

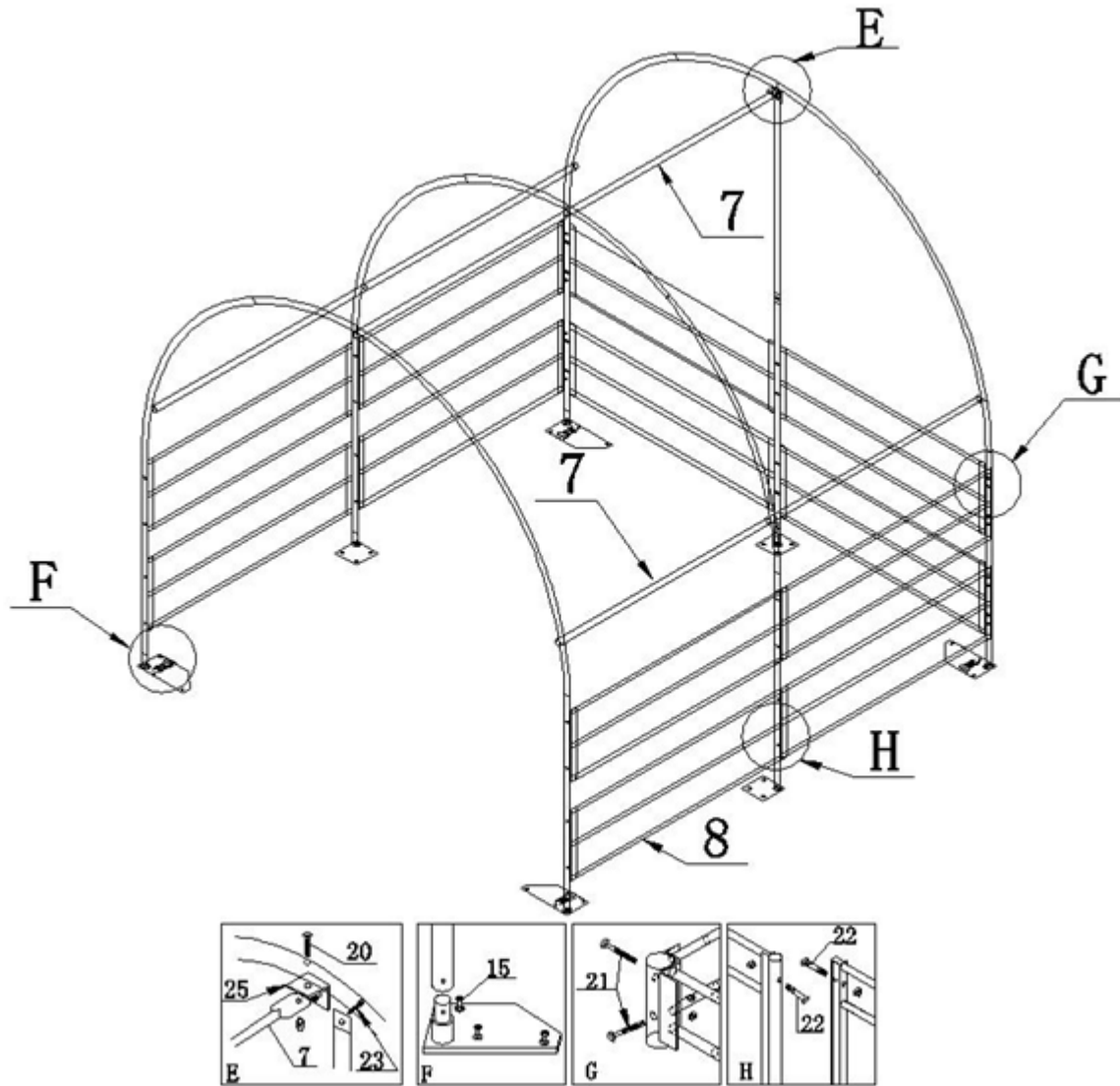

## Montering af teltdug

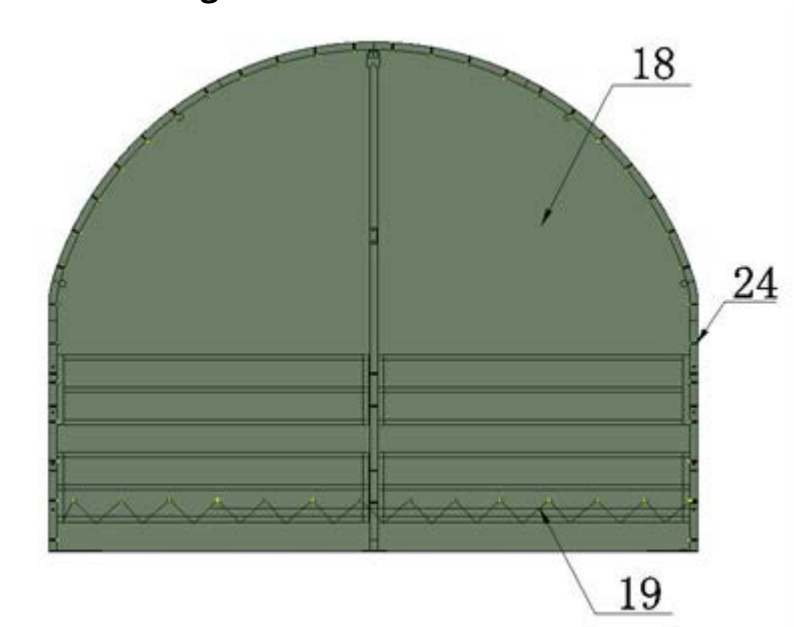

### Trin 1: Endegavl

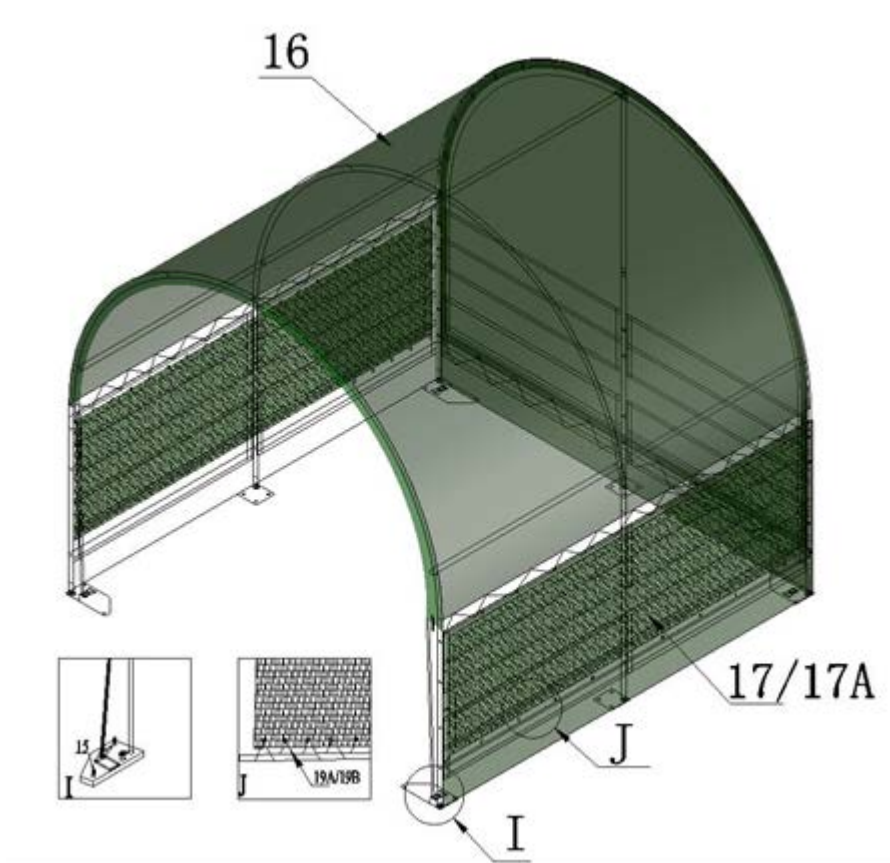

### Trin 2: Tag og sider (sider ikke inkluderet - kan tilkøbes)



## EU Overensstemmelseserklæring

<b>EU OVERENSSTEMMELSESERKLÆRING</b> 	
EU – importør:	P. Lindberg A/S Sdr. Ringvej 1 6600 Vejen Tlf.: 70212626 E-mail: salg@p-lindberg.dk CVR: 25903110 <a href="http://www.p-lindberg.dk">www.p-lindberg.dk</a>
Erklærer herved at følgende maskine:	<i>Læskure til dyrehold, tre størrelser PL varenr. 90 58 172 PL varenr. 90 58 173 PL varenr. 90 58 174</i>
Type / model:	SS-202 SS-303 SS-404
Er i overensstemmelse med følgende direktiver:	2011/305/EEC
Anvendte standarder og normer:	EN 13782:2005
Dato og ansvarlig underskrift:	Vejen d. 11-04-2018  P. Lindberg A/S  Erik T Lauritsen Direktør 

Vi forbeholder os ret til uden foregående varsel at ændre de tekniske parametre og specifikationer for dette produkt.



SE  
Original  
bruksanvisning



Art: 9058174

## Vindskydd för djurhållning 4x4x3,15 meter



Myrangan 4 - 745 37 Enköping - Tel. 010-209 70 50 -  
order@p-lindberg.se  
www.p-lindberg.se

## Vindskydd för djurhållning – Art. 9058174

**Beskrivning:** Tält med stativ av galvaniserat stål och PVC-tältduk. B4 x L4 x H3,15 meter.

**Användningsområde:** För förvaring av gods/maskiner, samt som vindskydd för djurhållning som skydd mot väder och vind, insekter och sol m.m.

### Säkerhetsanvisningar:

Läs hela manualen innan vindskyddet monteras. Det är mycket viktigt att vindskyddet förankras ordentligt. Vindskyddet är endast avsett som en tillfällig anordning och det rekommenderas inte att använda det som en permanent anordning.

### Fara:

Välj vindskyddets plats med omsorg.

### Håll säkert avstånd till elkablar.

Kontrollera om det finns luftledningar, grenar och annat. Kontrollera om det finns kablar och rör i marken innan grävning påbörjas.

Placera inte vindskyddet nära andra byggnader som det kan falla snö, is eller vatten från ner på vindskyddet.

Häng inte föremål från taket eller stödkablar.



### Varning:

Brandrisk.

Rök inte och använd inte utrustning med öppen låga (inklusive grill, eldstad) i eller runt vindskyddet.

Förvara inte brandfarliga vätskor/gaser (som bensin, fotogen, propan eller liknande) i eller runt vindskyddet.

Utsätt inte vindskyddets tak eller sidor för öppen eld eller andra värmekällor.



### Var försiktig:

Var försiktig när stativet ska resas. Använd skyddsglasögon. Fäst och bulta samman överliggande stänger. Var försiktig med ändarna på stängerna.

### Korrekt förankring och montering av stativet:

**Det är slutanvändarens ansvar att förankra stativet ordentligt.**

Säljaren ansvarar inte för skador på enheten eller innehållet på grund av vädret. Alla vindskydd som inte är ordentligt förankrade kan potentiellt flyga iväg och orsaka skada, som inte kommer att omfattas av garantin. Kontrollera regelbundet förankringarna för att vara säkra på vindskyddets stabilitet.



Observera: Tältduken kan snabbt avmonteras och förvaras på annat ställe inför dåligt väder. Om stark vind eller dåligt väder förutspås rekommenderas det att ta av tältduken.

### Rengöring/underhåll:

En åtsittande tältduk har längre livslängd och bättre prestanda. Håll därför alltid tältduken sträckt. Löst tyg kan påskynda nedbrytningen av duken.

Avlägsna snarast snö eller is som har fastnat på takkonstruktionen med en kvast eller annat verktyg med mjuka sidor. Var ytterst försiktig när du tar bort snö från tältduken – ta alltid bort det från de yttre sidorna av konstruktionen. Använd inte verktyg eller redskap med hårda kanter som krattor och spadar för att ta bort snö. Det kan göra hål i tältduken.



Använd inte blekmedel eller hårda slipmedel för att rengöra duken. Tältduken kan lätt rengöras med mild tvål och vatten.











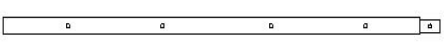
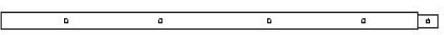
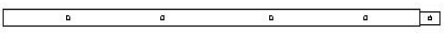
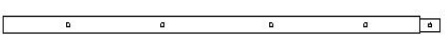

### Före användning:

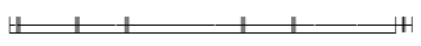
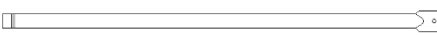

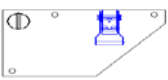

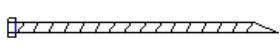
Det rekommenderas att vara 2 eller fler personer när vindskyddet ska monteras.

### Nödvändiga verktyg för monteringen:

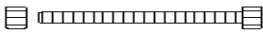
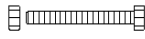

## Komponentlista

Nr	Beskrivning		Antal	Box
1	Böjd överdel, tvärbjälke		3	A
2	Böjd tvärbjälke till sidovägg		6	A
3	Stolpe till ändgavel (vänster)		1	A
4	Stolpe till ändgavel (höger)		1	A
5	Stolpar till förgavel		2	A
6	Stolpar till mittböjen		2	A
7	Takläkt		10	A
8	Staket till sidovägg		8	A
9	Nedre mittportal till ändgavel		1	A
10	Övre mittportal till ändgavel		1	A
11	Staket till ändgavel		4	A
12	Stolpfötter till hörn		4	A
13	Stolpfötter till mittböjen		2	A
14	Stolpfötter till ändgavel		1	A
15	Pålpinnar		22	A
16	Tältduk, tak		1	A
18	Tältduk, ändgavel		1	A
19	Rep till tältduk, tak och ändgavel		20 m	A

20	Vagnsbult M8x70 till takläkt (7) och utsida av staket		33+4	A
21	Bult M8x60 till tvärbjälkar		48+6	A
22	Bult M8x70 till insida av staket		12+4	A
23	Bult M10x30 till portal (10)		1+1	A
24	Buntband för fastsättning av ändgavel		36	A
25	Vinkelbeslag till portal (10)		1	A

## Uppställning av stativ

### Steg 1: Stolpfötter och pålspinnar

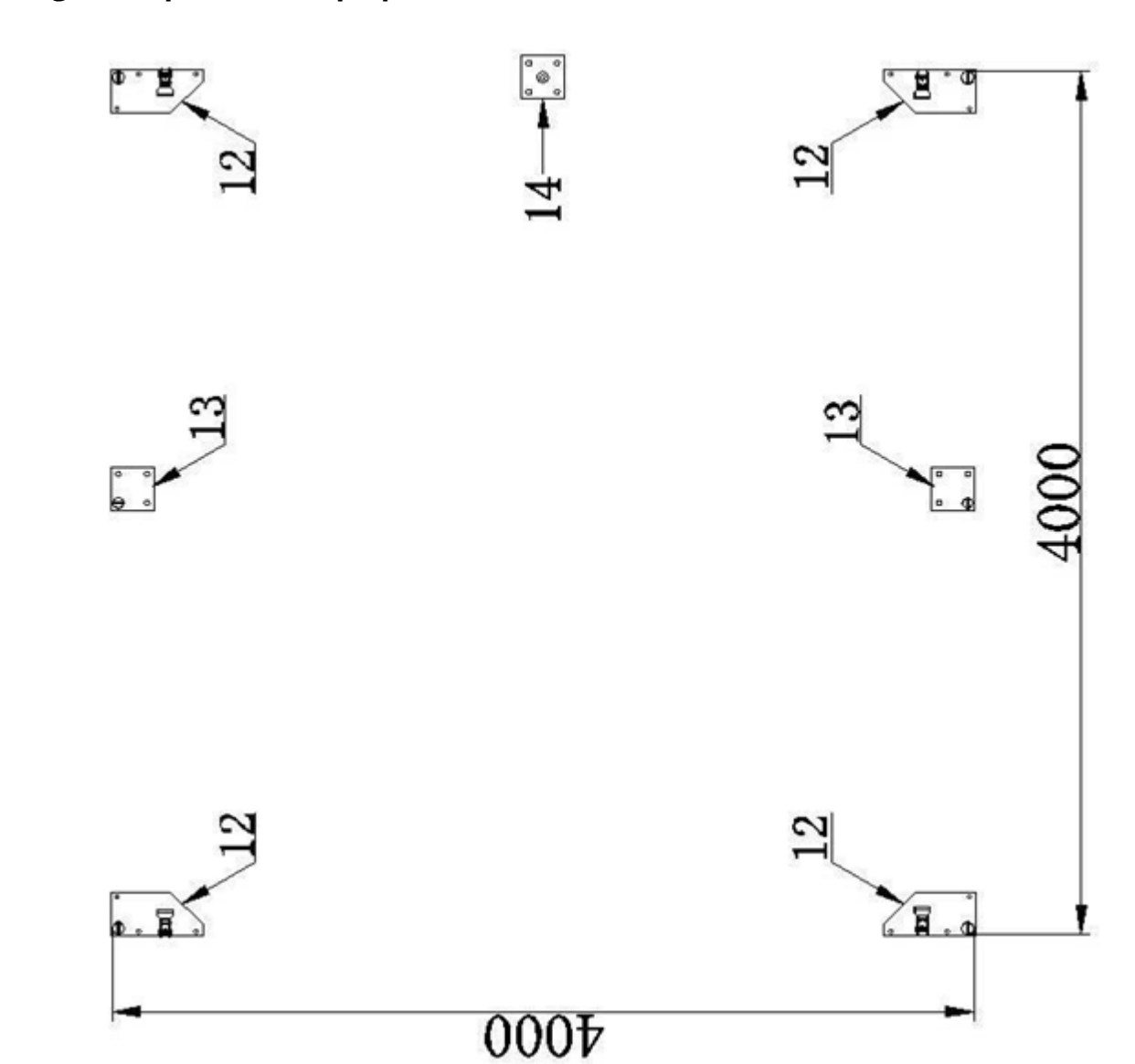

**Steg 2: Den första böjen (frontgaveln)**

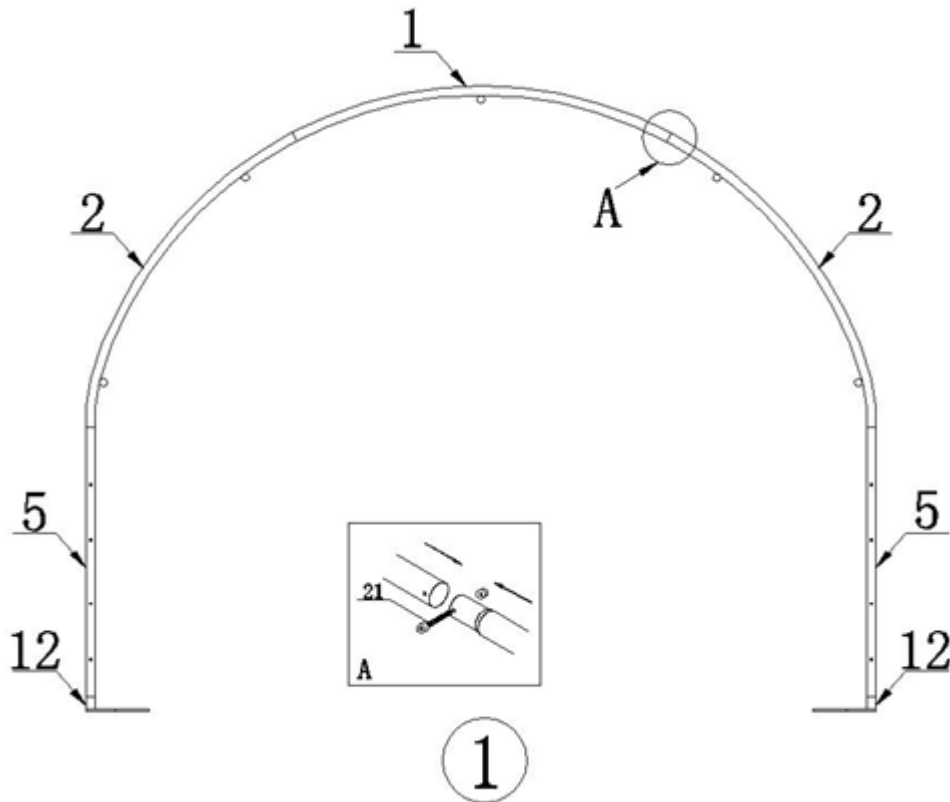

**Steg 3: Den andra böjen (mellanböjen)**

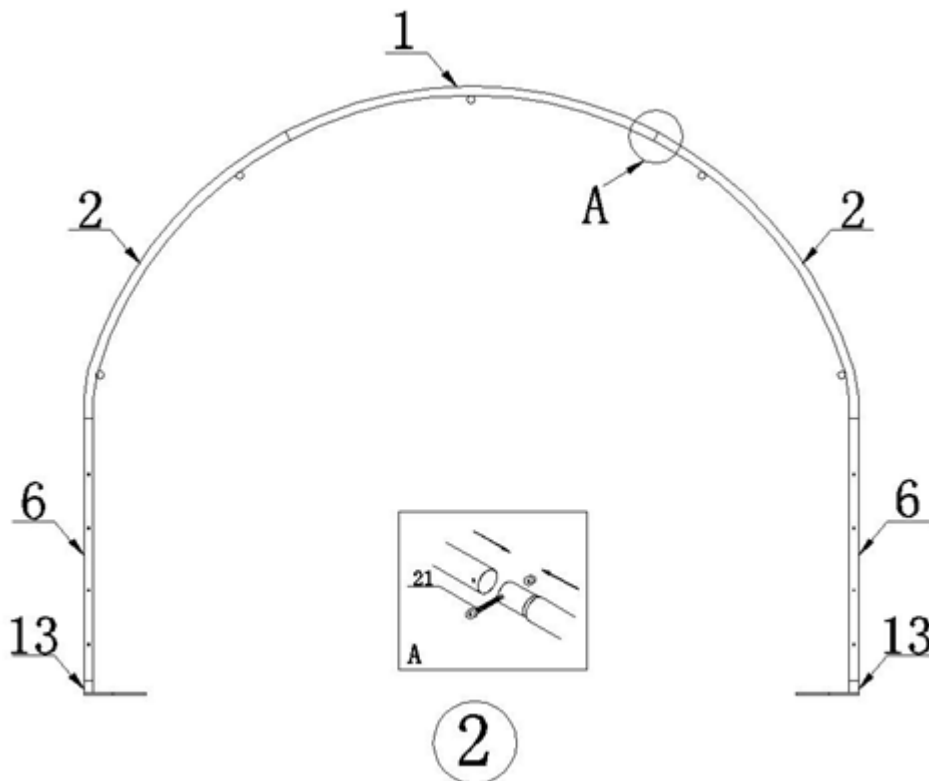

**Steg 4: Den sista böjen (ändgaveln)**

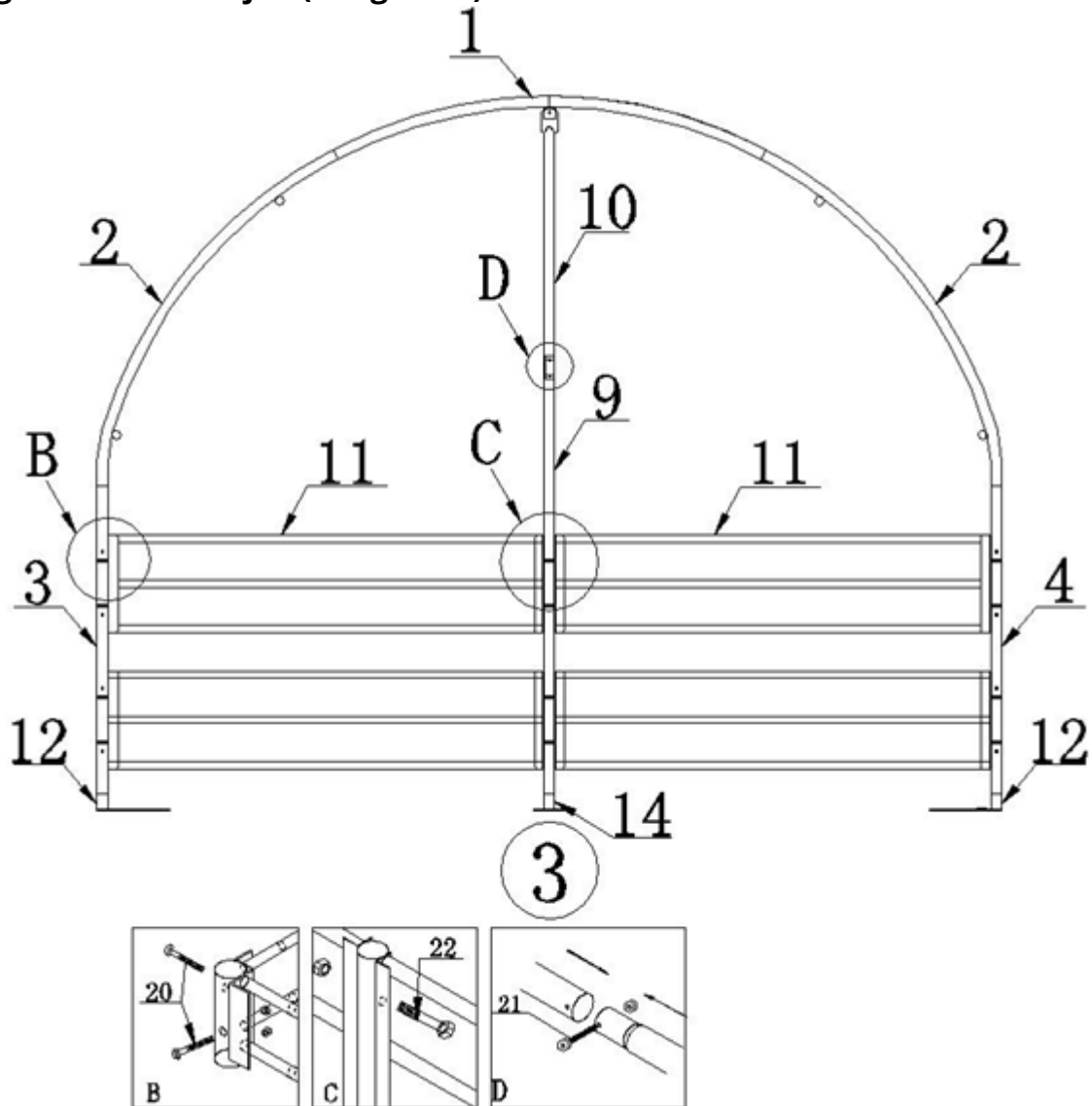

**Steg 5: Takläkt och sidostaket**

**Steg 6: Uppställning av stativet och fastsättning av stolpfötterna med pålpinnar**

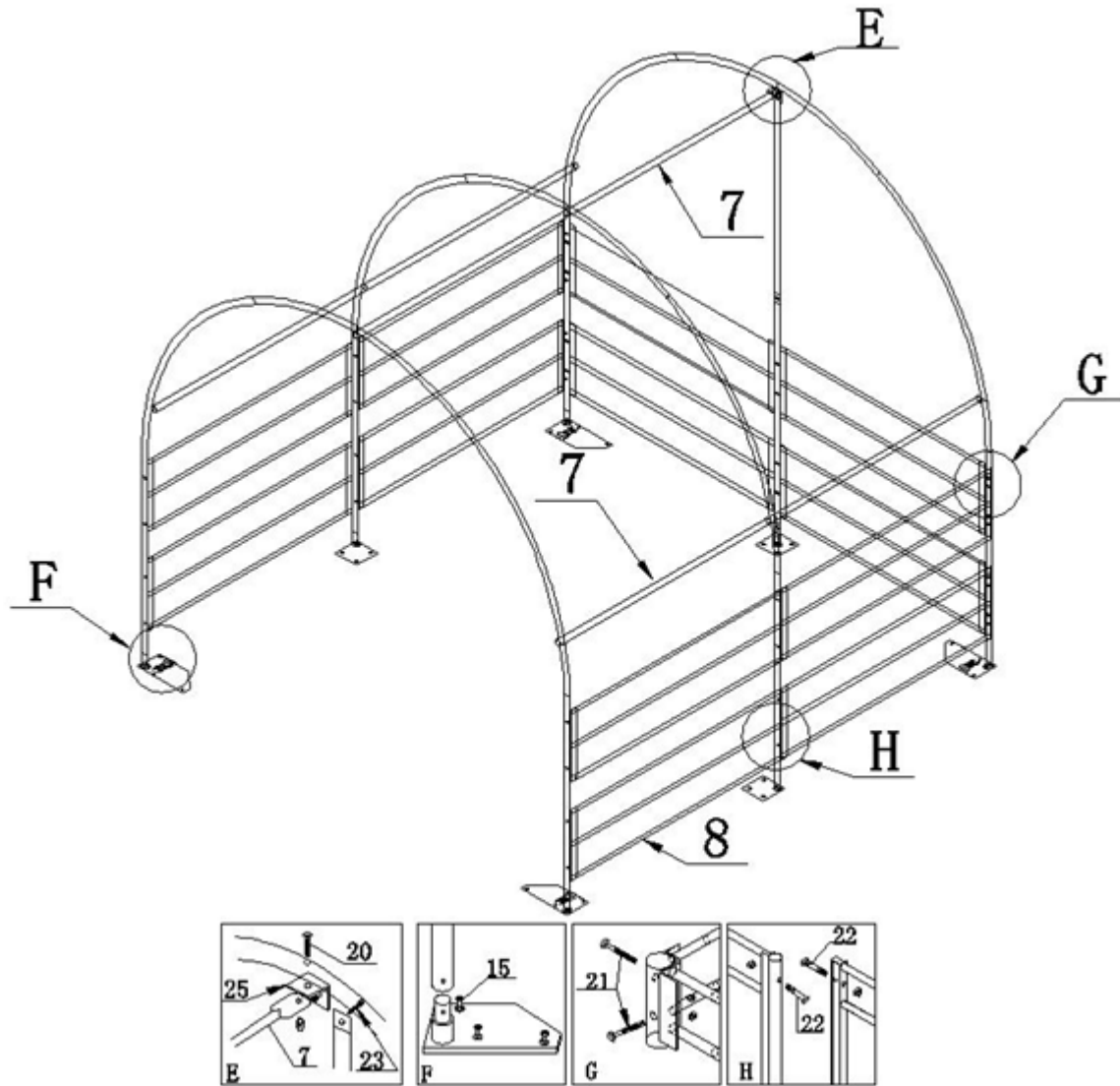

## Montering av tältduk

### Steg 1: Ändgavel

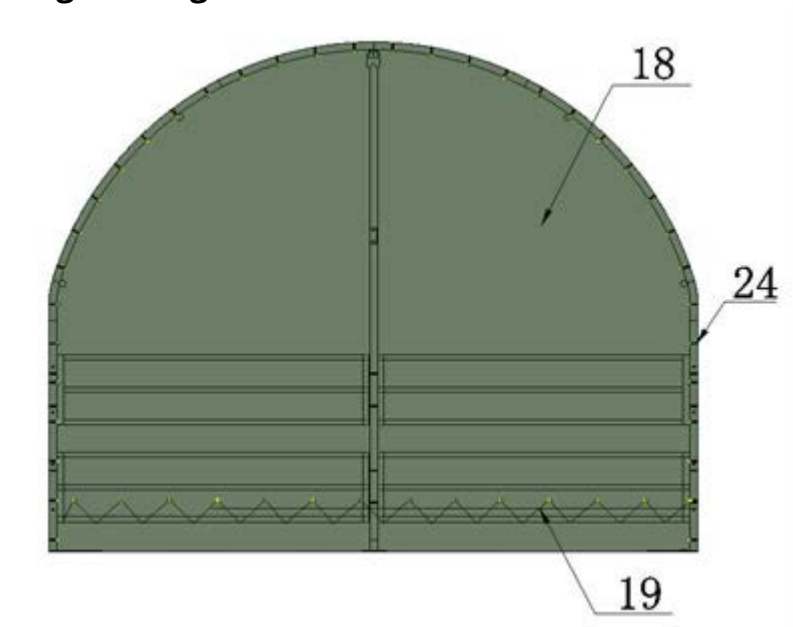

### Steg 2: Tak och sidor (sidor ingår inte - köps separat)

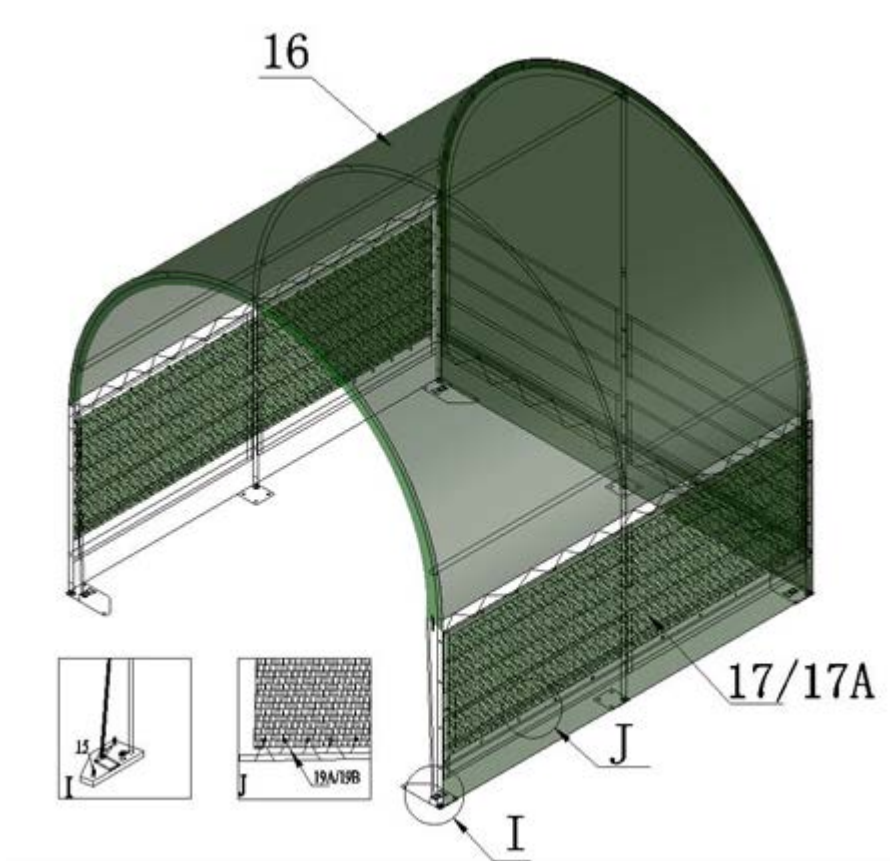



## EU-försäkran om överensstämmelse

<b>EU-FÖRSÄKRAN OM ÖVERENSSTÄMMELSE</b> 	
EU – importör:	P. Lindberg A/S Sdr. Ringvej 1 DK-6600 Vejen Tlf.: +45 70212626 E-mail: salg@p-lindberg.dk CVR: 25903110 <a href="http://www.p-lindberg.dk">www.p-lindberg.dk</a>
Härmed förklara att följande maskin:	<i>Vindskydd för djurhållning</i> <i>PL Art.: 90 58 172, 90 58 173 och 90 58 174</i>
Type / modell:	SS-202 SS-303 SS-404
Överensstämmer med följande direktiv:	<i>305/2011</i>
Tillämpade standarder och normer:	<i>EN 13782:2005</i>
Datum och signatur:	<i>Vejen d. 11-04-2018</i>  P. Lindberg A/S  Erik T Lauritsen Direktør 

Vi förbehåller oss rätten att ändra produktens tekniska parametrar och specifikationer utan föregående meddelande.



DE

Original

Bedienungsanleitung

---

**P.Lindberg**

Artikelnummer: 9058174

Zelthalle  
4x4x3,15 Meter



**P-Lindberg GmbH – Flensburger Str. 3 – D-24969 Großenwiehe**

**Tel. 03222/1097-888 Fax. 03222/1097-900**

**[www.p-lindberg.de](http://www.p-lindberg.de)**

## Zelthalle – Artikelnr. 9058174

**Beschreibung:** Zelt mit Gestell aus verzinktem Stahl und PVC-Zeltplane. B x L4 x H3,15 Meter.

**Einsatzbereiche:** Für die Aufbewahrung von Geräten/Maschinen sowie als Unterstand für Tiere zum Schutz vor Wind & Wetter, Insekten, Sonne usw.

### Sicherheitsanweisungen:

Lesen Sie vor dem Aufbau der Zelthalle dieses Handbuch. Es ist wirklich wichtig, dass die Halle angemessen verankert wird. Die Halle ist lediglich als Übergangslösung gedacht. Es wird empfohlen, diesen nicht als dauerhafte Lösung zu verwenden.

### Gefahr:

Wählen Sie die Platzierung des Unterstands sorgfältig.

**Halten Sie ausreichend Abstand zu Stromleitungen.**

Überprüfen Sie, dass keine überhängenden Versorgungsleitungen, Zweige oder Sonstiges im Weg sind.

Überprüfen Sie den Boden auf Leitungen und Rohre hin, bevor mit den Grabungsarbeiten begonnen wird.

Stellen Sie den Unterstand nicht in der Nähe von Dachvorsprüngen oder anderen Elementen auf, von denen Schnee oder Eis fallen oder Wasser auf den Unterstand fließen kann.

Hängen Sie keine Gegenstände an die Decke oder die Stützkabel.



### Warnung:

Brandgefahr.

Rauchen Sie nicht und verwenden Sie keine Geräte mit offenen Flammen (inkl. Grill, Feuerstelle, Fritteuse, Räucheröfen und Laternen) im oder in der Nähe des Unterstands.

Bewahren Sie im oder in der Nähe des Unterstands keine brennbaren Flüssigkeiten/Gase (wie Benzin, Petroleum, Propan usw.) auf.

Das Dach und die Seiten des Unterstands dürfen offenem Feuer oder anderen Zündquellen nicht ausgesetzt werden.



### ACHTUNG:

Seien Sie vorsichtig, wenn Sie das Gestell aufstellen. Verwenden Sie Sicherheitsbrillen. Schrauben Sie übereinander liegende Stangen zusammen. Passen Sie auf die Enden der Stangen auf.

### Richtige Verankerung und Montage des Gestells:

**Der Endverbraucher trägt die Verantwortung dafür, das Gestell ordentlich zu verankern.**

Der Verkäufer ist nicht verantwortlich für Schäden am Unterstand oder den gelagerten Gegenständen aufgrund des Wetters. Jeder Unterstand, der nicht sicher verankert ist und potenziell wegfliegen und Schäden verursachen kann, ist von der Garantie ausgeschlossen. Kontrollieren Sie die Verankerung regelmäßig, um die Stabilität zu prüfen.

Achtung: Die Zeltplane kann vor schlechtem Wetter rasch entfernt und aufbewahrt werden. Es wird empfohlen, die Zeltplane vor schlechtem Wetter oder starkem Wind zu entfernen.

**Reinigung/Wartung:**

Eine straff sitzende Zeltplane bedeutet eine längere Lebensdauer und eine bessere Funktion. Sorgen Sie daher stets dafür, dass die Zeltplane straff ist. Loser Stoff kann die Abnutzung der Plane erhöhen.

Entfernen Sie Schnee oder Eis, das sich am Dach gesammelt hat, sofort mit einem Besen, Mopp oder einem anderen Gerät mit einem weichen Ende. Seien Sie beim Entfernen von Schnee von der Zeltplane extrem vorsichtig. Entfernen Sie stets die Seite der Konstruktion. Verwenden Sie kein Werkzeug und keine Geräte mit scharfen Kanten wie Rechen oder Schaufeln zum Entfernen von Schnee. Dies könnte Löcher in die Zeltplane machen.



Verwenden Sie keine Bleichmittel oder starke Scheuerprodukte zum Reinigen der Zeltplane. Die Zeltplane wird vorsichtig mit milder Seife und Wasser gereinigt.













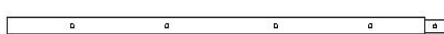
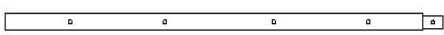
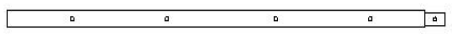

**Vor der Inbetriebnahme:**

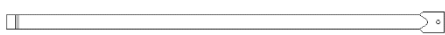

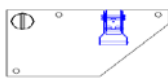

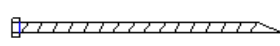
Es wird empfohlen, dass mindestens 2 Personen den Aufbau des Unterstands durchführen.

**Für den Zusammenbau notwendiges Werkzeug:**

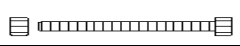
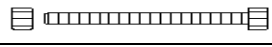

## Komponentenliste

Nr.	Beschreibung	Stk.	Box	
1	Gebogener Querbalken oben		3	A
2	Gebogener Querbalken für Seitenwand		6	A
3	Stützen für Giebel (links)		1	A
4	Stützen für Giebel (rechts)		1	A
5	Stützen für Giebel vorne		2	A
6	Stützen für mittleren Bogen		2	A
7	Dachlatten		10	A
8	Gestell für Seitenwand		8	A
9	Untere mittige Pforte für Endgiebel		1	A
10	Obere mittige Pforte für Endgiebel		1	A
11	Gestell für Endgiebel		4	A
12	Stützenfüße für Ecken		4	A
13	Stützenfüße für Bogen mittig		2	A
14	Stützenfüße für Endgiebel		1	A
15	Anker		22	A
16	Zeltplane, Dach		1	A
18	Zeltplane, Endgiebel		1	A
19	Seil für Zeltplane, Dach und Endgiebel		20m	A

20	Bretterbolzen M8x70 für die Dachlatten (7) und die Außenseite des Gestells		33+4	A
21	Schraube M8x60 für Querbalken		48+6	A
22	Schraube M8x70 für die Innenseite des Gestells		12+4	A
23	Schraube M10x30 für die Pforte (10)		1+1	A
24	Kabelbinder zum Befestigen des Endgiebels		36	A
25	Winkelbeschlag für Pforte (10)		1	A

## Aufstellen des Gestells

### Schritt 1: Stützenfüße und Anker

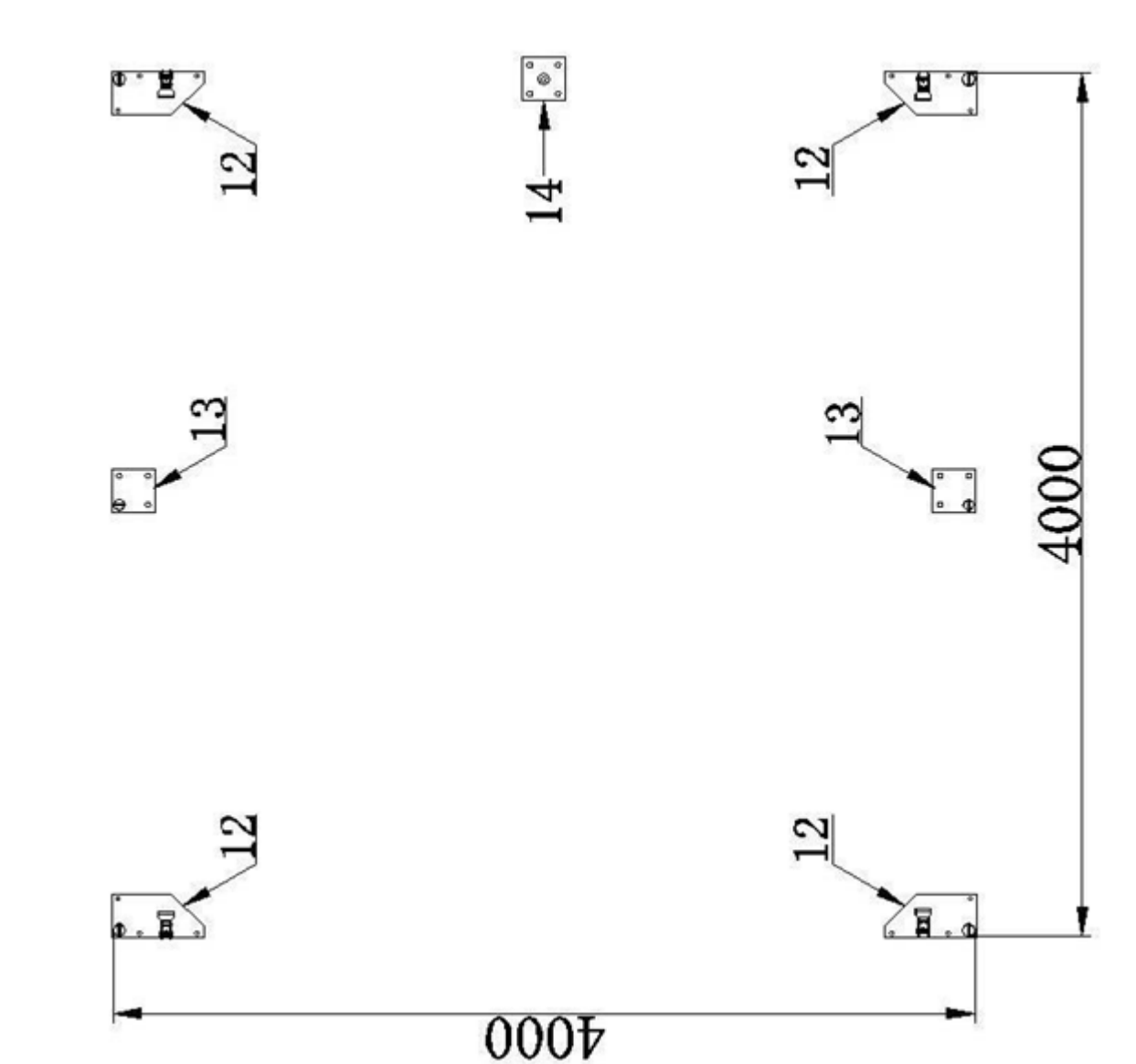



## Schritt 2: Erster Bogen (Giebel vorne)

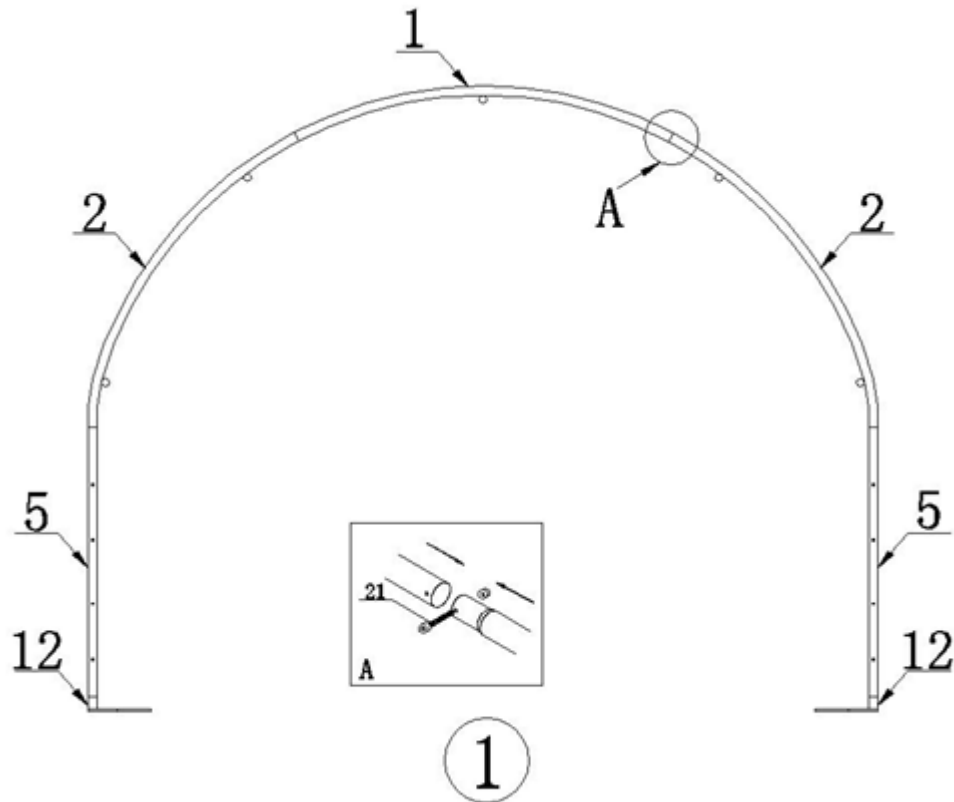

## Schritt 3: Zweiter Bogen (Bogen mittig)

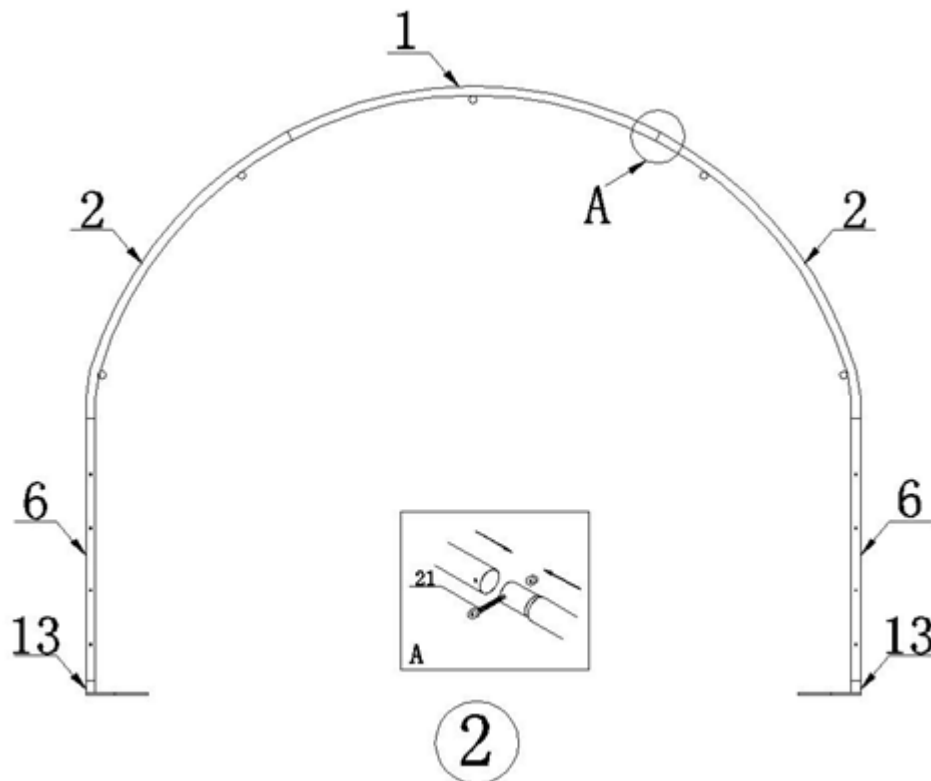

## Schritt 4: Letzter Bogen (Giebel hinten)

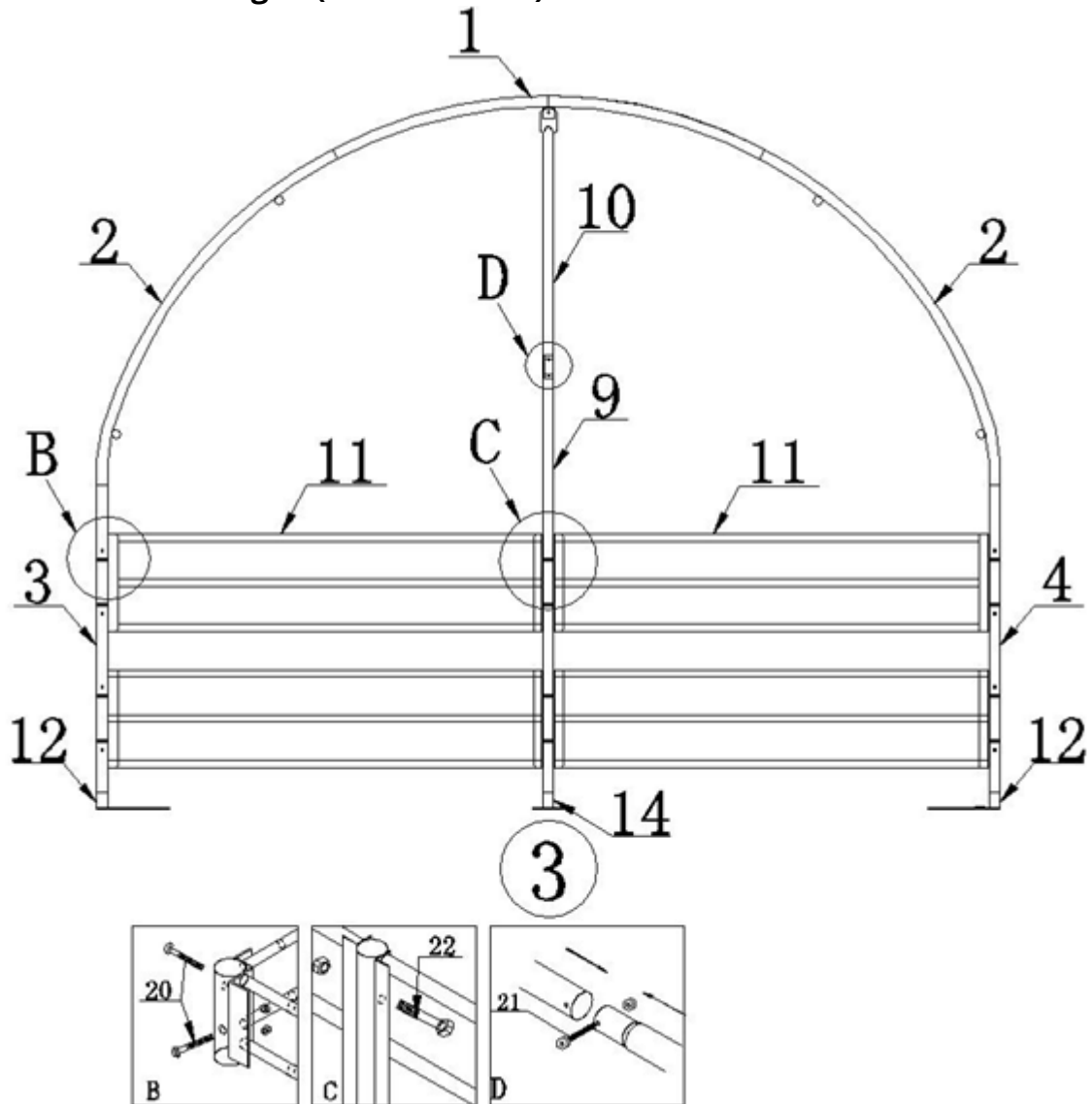

## Schritt 5: Dachlatten und Seitengestell

## Schritt 6: Anpassen des Gestells und befestigen der Stützenfüße an den Pfählen

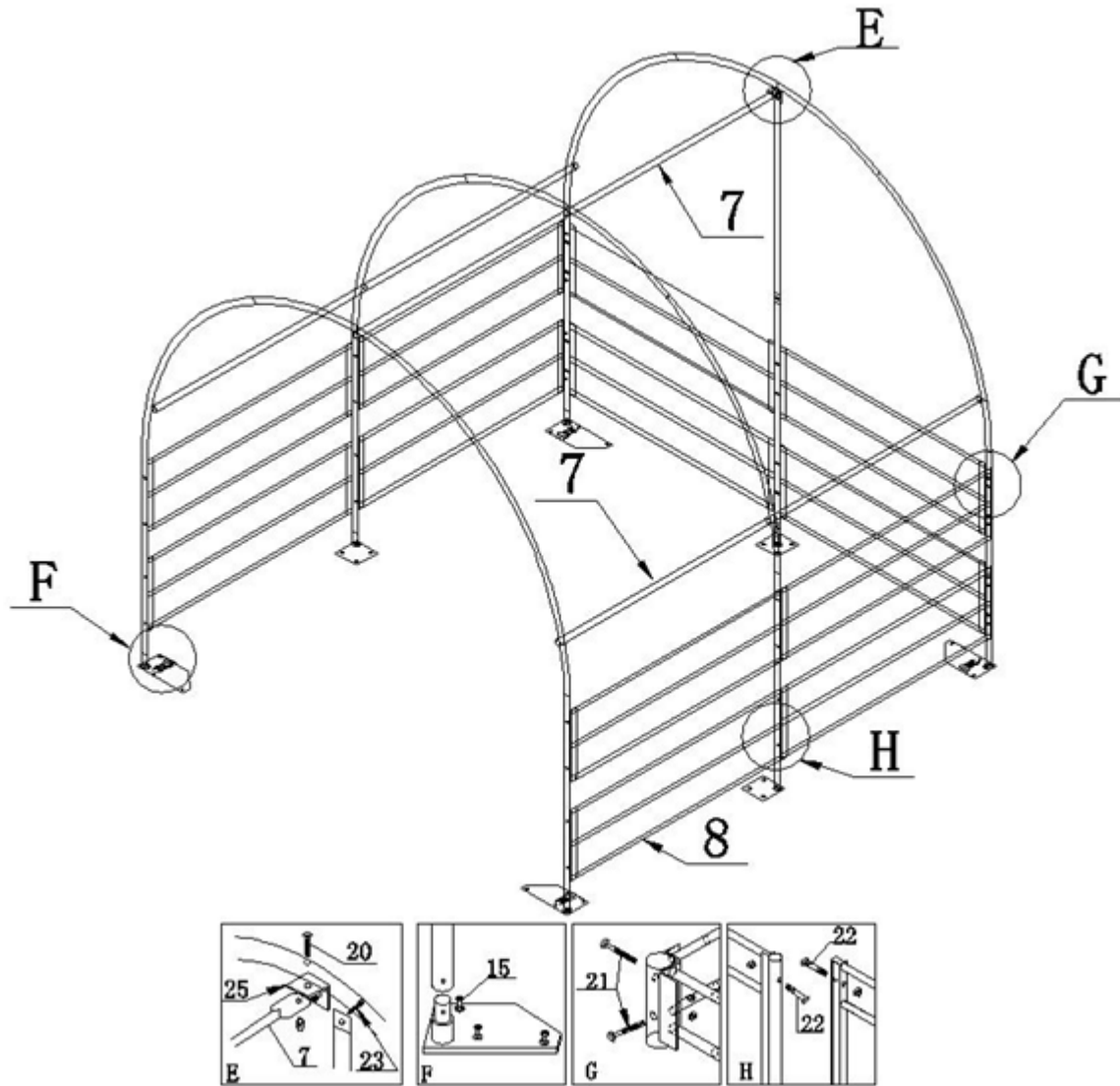

## Montage der Zeltplane

### Schritt 1: Endgiebel

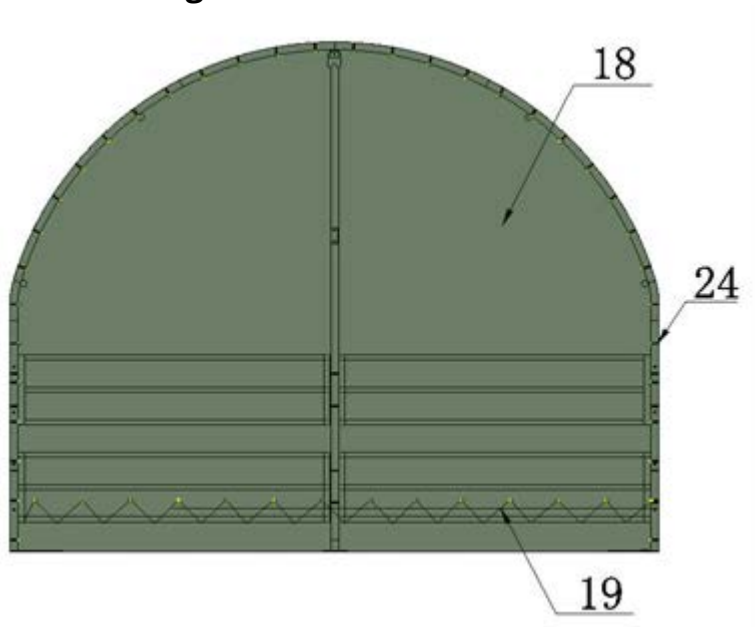

Schritt 2: Dach und Seiten (Seiten nicht im Lieferumfang enthalten - können separat erworben werden)

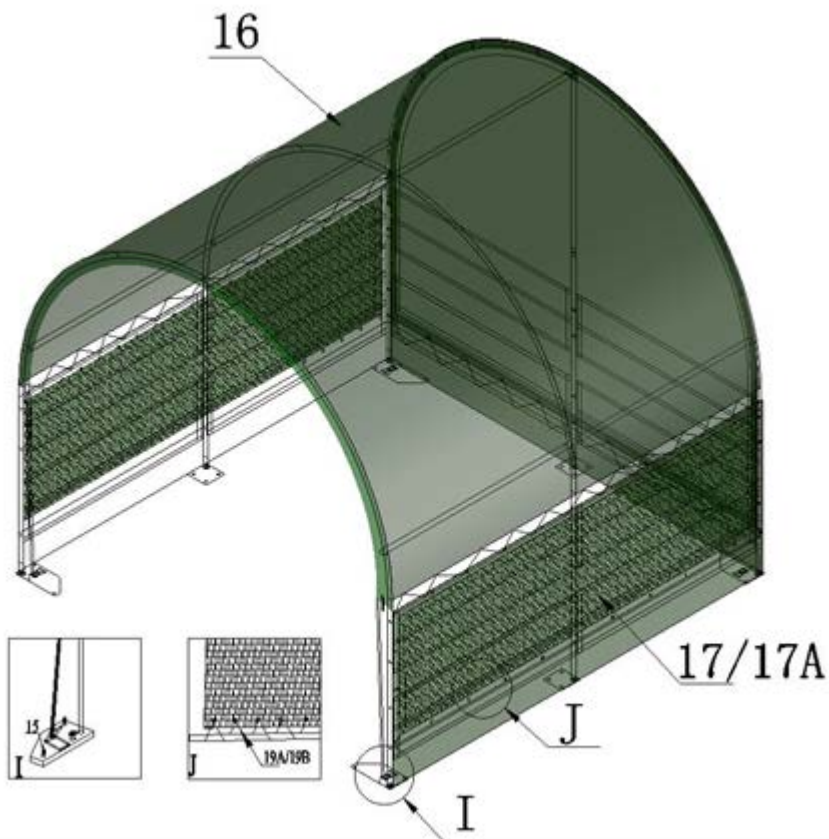

## EU-Konformitätserklärung

<b>EU-KONFORMITÄTSERKLÄRUNG</b>		<b>CE</b>
EU – importeur: P. Lindberg A/S Sdr. Ringvej 1 DK-6600 Vejen Tlf.: +45 70212626 E-mail: <a href="mailto:salg@p-lindberg.dk">salg@p-lindberg.dk</a> CVR: 25903110 <a href="http://www.p-lindberg.dk">www.p-lindberg.dk</a>		
Hiermit wird bestätigt dass die folgenden Maschine::	Zelthalle PL Artikelnr.: 90 58 172, 90 58 173 und 90 58 174	
Typ / Modell:	SS-202 SS-303 SS-404	
Entspricht den folgenden Richtlinien:	305/2011	
Angewandte Standards und Normen:	EN 13782:2005	
Datum und Unterschrift:	Vejen d. 11-04-2018  P. Lindberg A/S  Erik T Lauritsen Direktør	<b>CE</b>

Wir behalten uns das Recht vor, ohne vorherige Information technische Parameter oder Spezifikationen für dieses Produkt zu ändern.



EN

Original

User instructions

---



Item number: 9058174

## Livestock Shelter 4 x 4 x 3.15 metres



**Sdr. Ringvej 1 - DK-6600 Vejen**  
**Tel. +45 7021 2626 - Fax +45 7021 2630**  
**[www.p-lindberg.dk](http://www.p-lindberg.dk)**

## Livestock Shelter – Item no. 9058174

**Description:** Tent with galvanised steel frame and PVC tarpaulin. B4 x L4 x H3.15 metres.

**Areas of use:** For storing goods/machines and for sheltering livestock against the elements, insects, sun, etc.

### Safety instructions:

Read the entire manual before assembling the shelter. It is essential to properly anchor the shelter. The shelter is only intended as a temporary set-up, and it is not advisable to use it as a permanent structure.

### Danger:

Carefully select where to place the shelter.

#### Keep well away from electrical cables.

Check for overhead electric mains, branches and similar obstructions.

Check the subsoil for cables and pipelines before beginning to excavate.

Do not place the shelter close to eaves or other structural components from which snow or ice can fall or from which water can flow onto the shelter.

Do not hang objects from the ceiling or support ropes.



### Warning:

Fire hazard.

Do not smoke or use equipment with open flames (including barbecue grills, fire bowls, deep fryers, smoking ovens and lanterns) in or around the shelter.

Do not store flammable fluids or combustible gases (such as petrol, petroleum, propane, etc.) in or around the shelter.

Do not expose the shelter roof or sides to naked flames or other sources of fire.



### Caution:

Be cautious when erecting the frame. Wear safety goggles. Fixate and bolt together the overhead bars. Be careful of the bars' ends.

### Correct frame anchoring and assembly:

***The end-user is responsible for properly anchoring the frame.***

The seller is not responsible for any damage to the structure or its contents caused by inclement weather. Any shelter that is not securely anchored can potentially be blown



away and cause damage that will not be covered by the guarantee. Check the anchors frequently to ensure the stability of the shelter.

Note: The tarpaulin can be quickly removed and stored before bad weather sets in. If high winds or bad weather is predicted, it is advisable to remove the tarpaulin.

### **Cleaning/maintenance:**

A tight-fitting tarpaulin ensures a longer service life and better function. Therefore, keep the tarpaulin taut at all times. Loosely attached material can hasten the disintegration of the tarpaulin.

Immediately remove snow or ice amassed on the roof structure using a broom, mop or other tool with soft sides. Be very careful when removing snow from the tarpaulin: always remove it from the outer sides of the structure. Never remove snow using tools or equipment with hard edges, such as rakes or shovels. These could puncture the tarpaulin.



Do not clean the tarpaulin with bleach or strong, abrasive products. It is easy to clean the tarpaulin with mild soapy water.











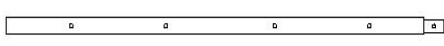
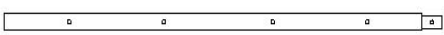
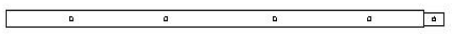

### **Before starting to use the shelter:**



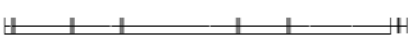
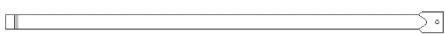

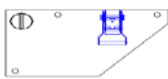
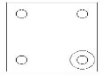

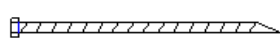
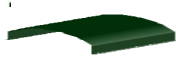
It is recommended that the shelter be assembled by at least two people.

### **Tools required for assembly:**

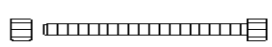

## List of components

No.	Description		Pcs.	Box
1	Curved top crossbeam		3	A
2	Curved crossbeam for side wall		6	A
3	Post for rear gable (left)		1	A
4	Post for rear gable (right)		1	A
5	Posts for front opening		2	A
6	Posts for centre arch		2	A
7	Roof battens		10	A
8	Fence for side wall		8	A
9	Bottom centre portal frame for rear gable		1	A
10	Top centre portal frame for rear gable		1	A
11	Fence for end gable		4	A
12	Post supports for corner		4	A
13	Post supports for centre arch		2	A
14	Post supports for rear gable		1	A
15	Post-support pegs		22	A
16	Tarpaulin, roof		1	A
18	Tarpaulin, rear gable		1	A
19	Rope for tarpaulin, roof and rear gable		20 m	A

20	Coach bolt M8 x 70 for roof battens (7) and exterior fence surface		33+4	A
21	Bolt M8 x 60 for crossbeams		48+6	A
22	Bolt M8 x 70 for interior fence surface		12+4	A
23	Bolt M10 x 30 for portal frame (10)		1+1	A
24	Cable ties for fixating end gable		36	A
25	Angle bracket for portal frame (10)		1	A

## Erecting the frame

### Step 1: Post supports and pegs

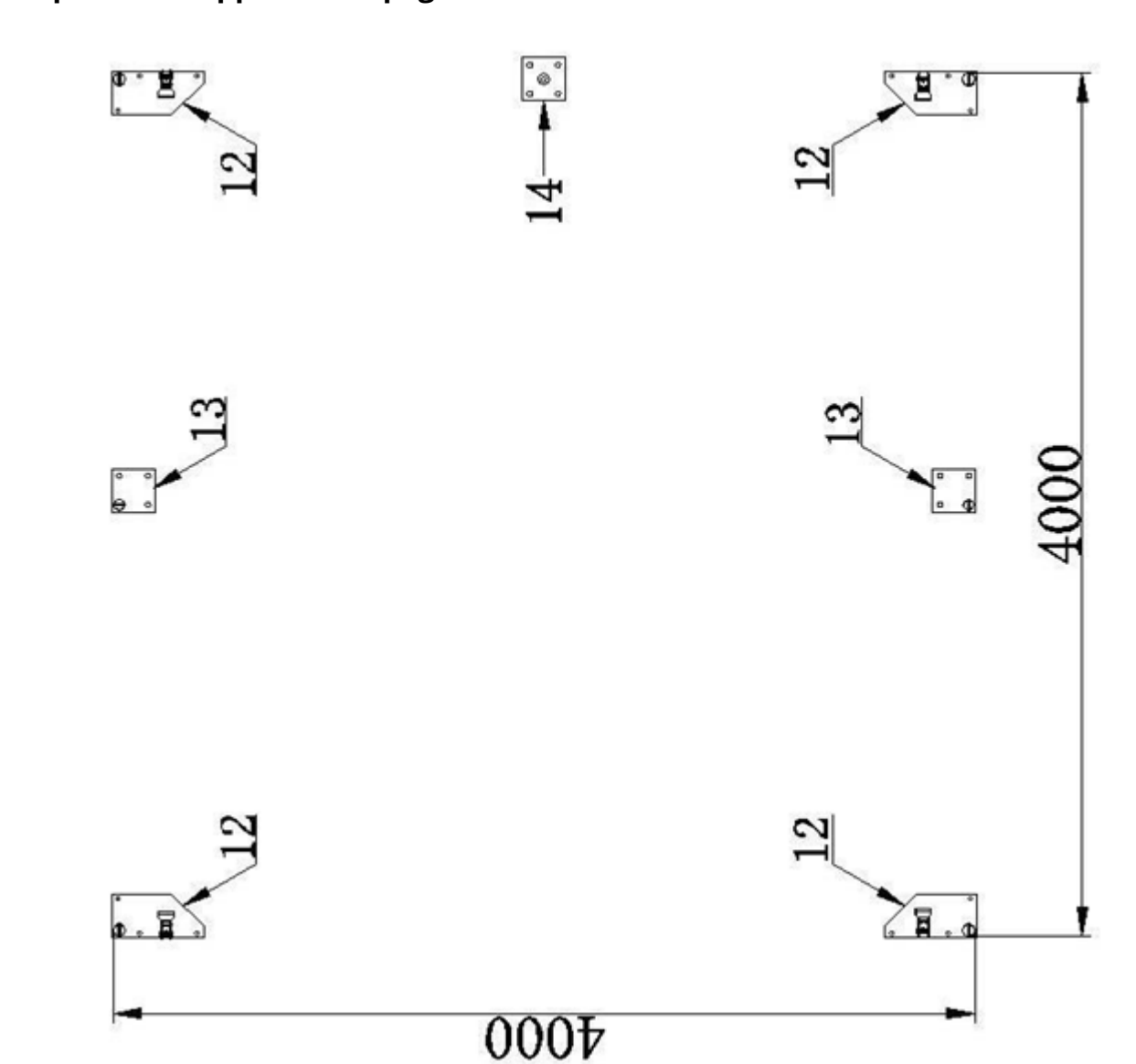

**Step 2: First arch (front opening)**

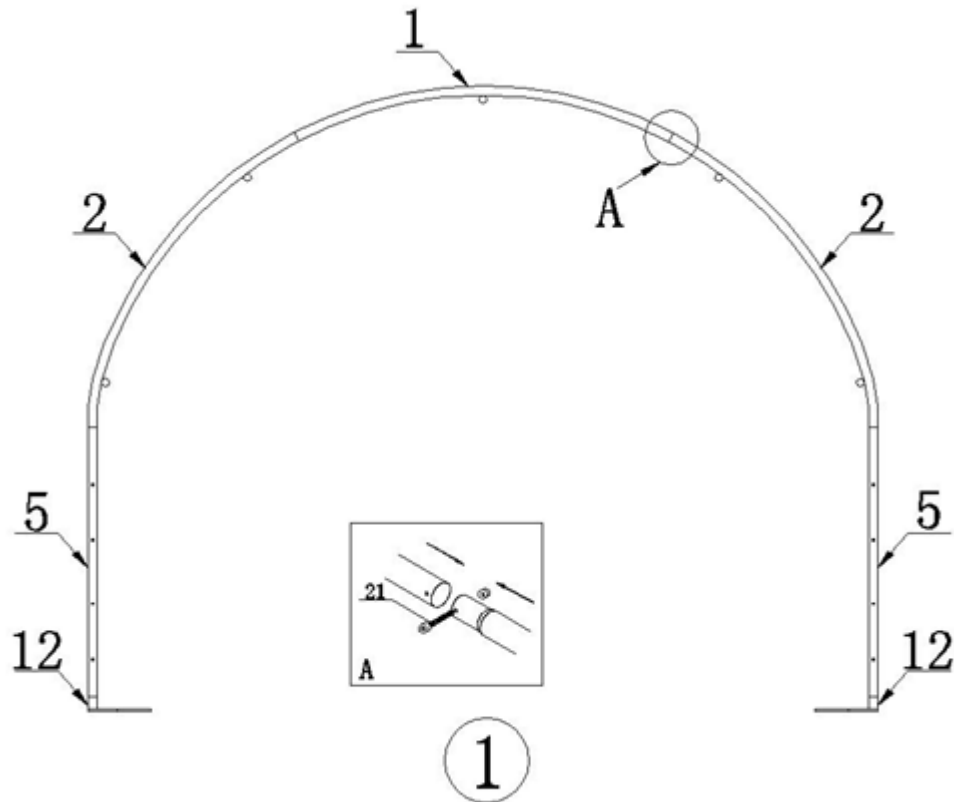

**Step 3: Second arch (centre arch)**

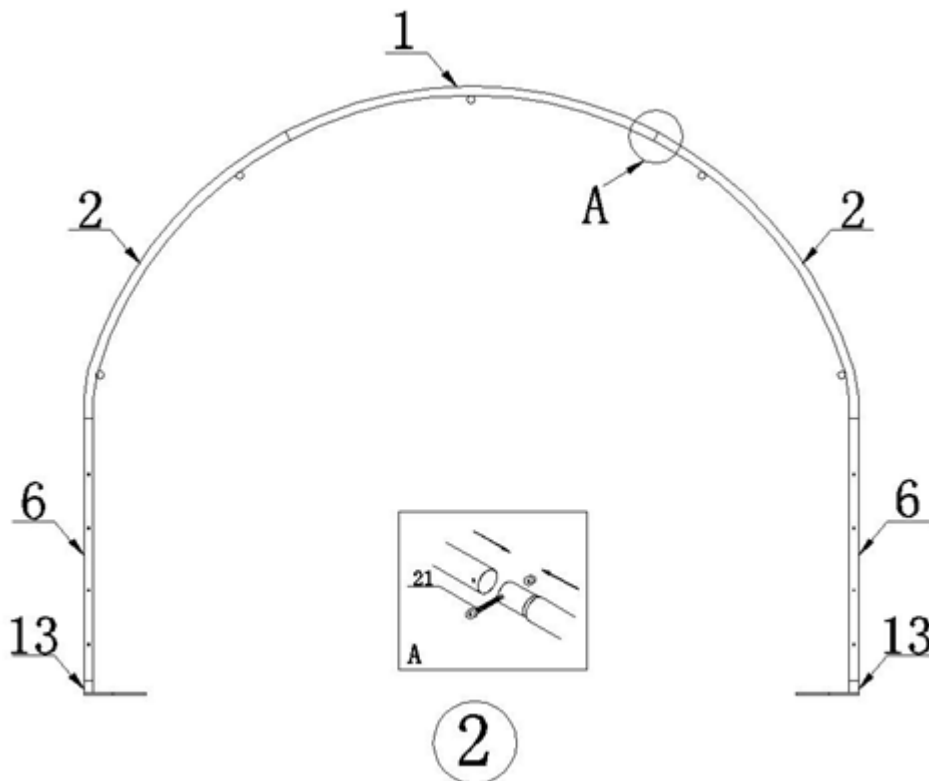

**Step 4: Last arch (rear gable)**

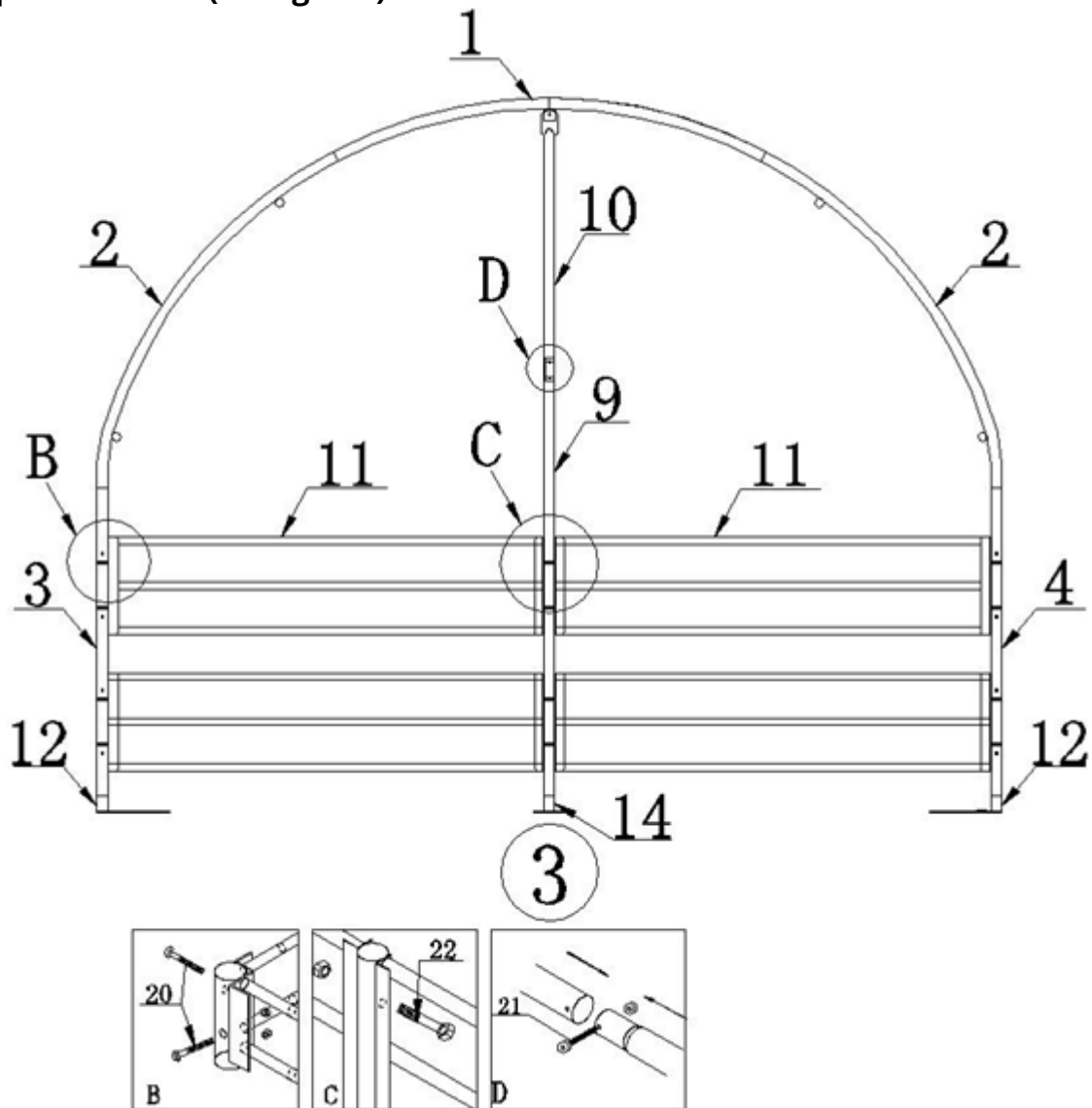

**Step 5: Roof battens and side fence**

**Step 6: Straightening out the frame and attaching post supports with pegs**

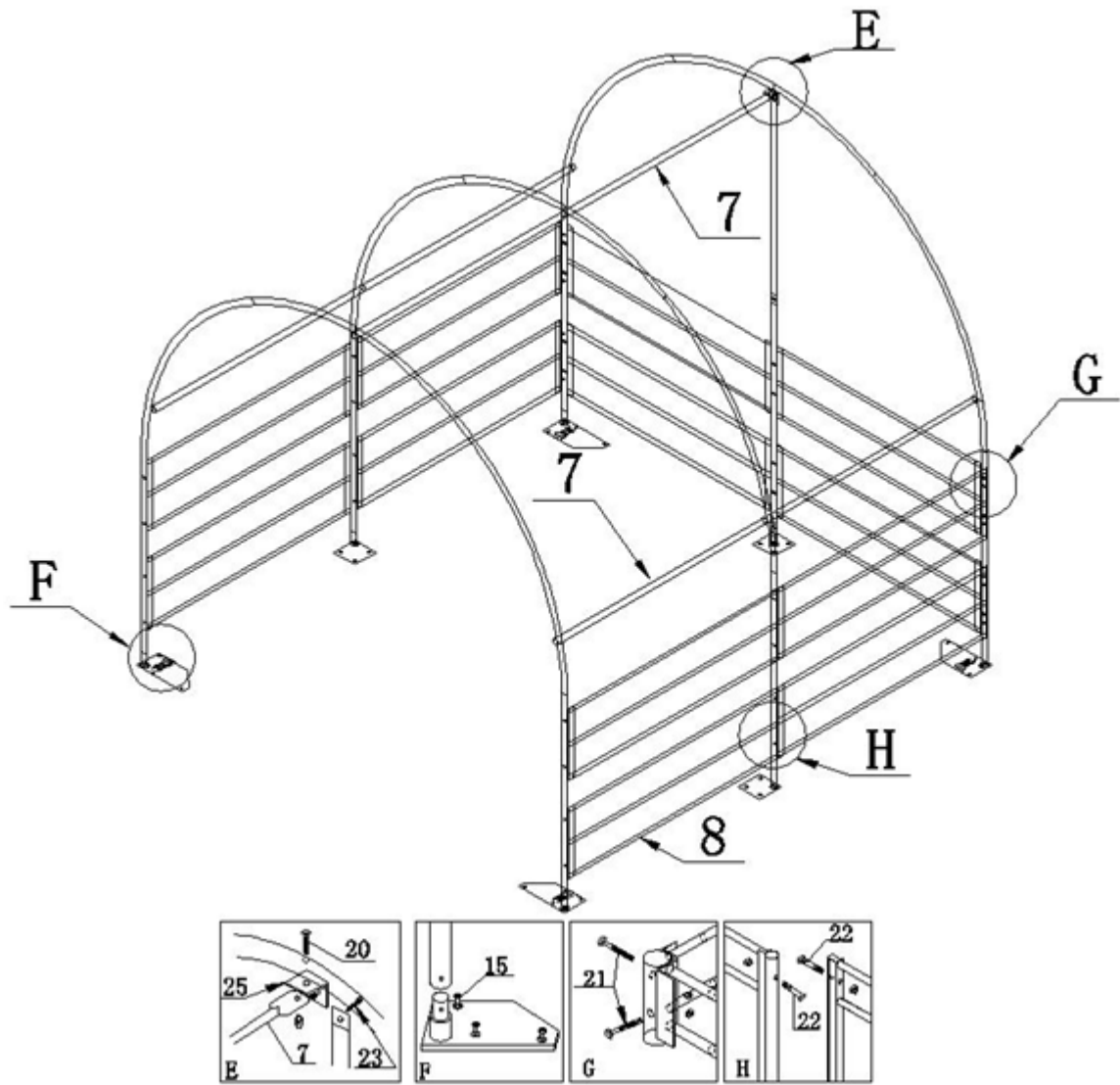

## Mounting the tarpaulin

### Step 1: Rear gable

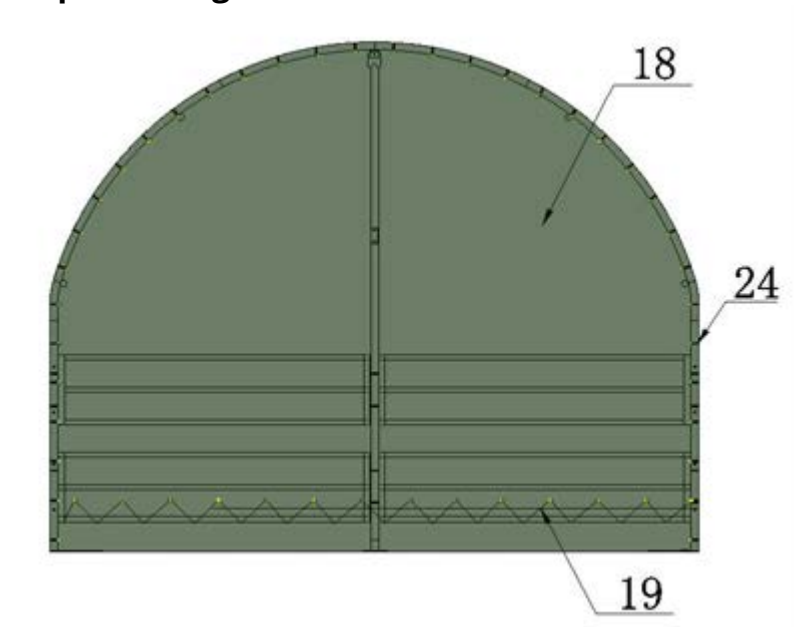

### Step 2: Roof and sides (sides are not included, can be purchased separately)

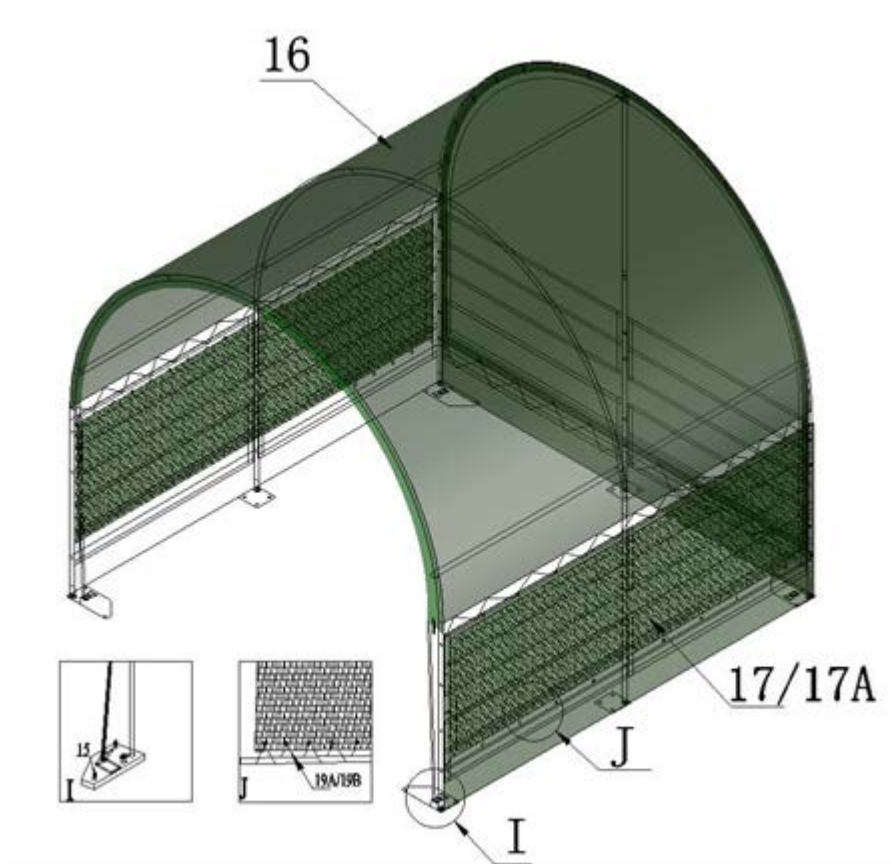



## EU Declaration of Conformity

<b>EU DECLARATION OF CONFORMITY</b>		<b>CE</b>
EU – importer:	P. Lindberg A/S Sdr. Ringvej 1 DK-6600 Vejen Phone: +45 70212626 E-mail: salg@p-lindberg.dk CVR: 25903110 <a href="http://www.p-lindberg.dk">www.p-lindberg.dk</a>	
Hereby declare that the following machine:	<i>Livestock shelters</i> <i>PL Item no.: 90 58 172, 90 58 173 and 90 58 174</i>	
Type / model:	<i>SS-202</i> <i>SS-303</i> <i>SS-404</i>	
Complies with the following directives:	<i>305/2011</i>	
Applied standards and norms:	<i>EN 13782:2005</i>	
Date and signature:	<i>Vejen d. 11-04-2018</i>  <i>P. Lindberg A/S</i>  <i>Erik T Lauritsen</i> <i>Direktør</i>	
		<b>CE</b>

We reserve the right to change the technical parameters and specifications for this product without giving advance notice.