

# Original Manual

# P.Lindberg

9035575, 9035576 & 9046699

DK/N: Partytelt

S: Partytält

D: Partyzelt

GB: Party Tent

**5 x 8 M**



DK

S

D

GB

[www.p-lindberg.dk](http://www.p-lindberg.dk)  
[www.p-lindberg.no](http://www.p-lindberg.no)  
[www.p-lindberg.se](http://www.p-lindberg.se)  
[www.p-lindberg.de](http://www.p-lindberg.de)



DK  
Original  
Brugsanvisning















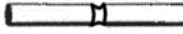





**Partytelt 5 x 8 meter - 9035575**

**Bundramme til partytelt 5 x 8 meter - 9046699**

**Partytelt 5 x 8 meter - inkl. bundramme - 9035576**

**Komponenter**

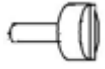
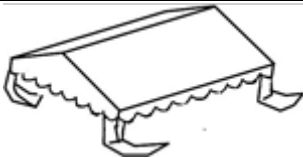
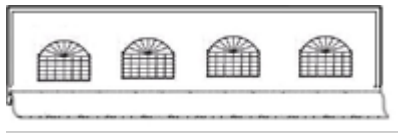
	Beskrivelse		Antal
1	Kort stang		10 stk.
2	Lang stang		22 stk.
3	Ben, mellem -u. fod		6 stk.
4	Ben, hjørne -u. fod		4 stk.
5	Samlerør		10 stk.
6	Samler, hjørne/side		4 stk.
7	Samler, mellem/side		6 stk.
8	Samler, tag/gavl		2 stk.
9	Samler, tag/mellem		3 stk.

10	Fod		10 stk.
11	Reb		4 stk.
12	Spiral pløkke		4 stk.
13	Lang pløkke		10 stk.
14	Kort pløkke		36 stk.
15	Elastik m. kugle		22 stk.
16	Elastik m. kugle		76 stk.
17	Skrue		74 stk.
18	Tagdug		1 stk.
19	Sidepaneler		2 stk.
20	Endegavle		

## Montering

1. Vælg placering på et fladt areal. Pak teltet ud og kontroller at alle dele er leveret. Saml taget ved at forbinde samlerne 6, 7, 8 og 9 med stængerne 1, 2 og 5. Sørg for at spændeskruen er sat fast i hver stang.

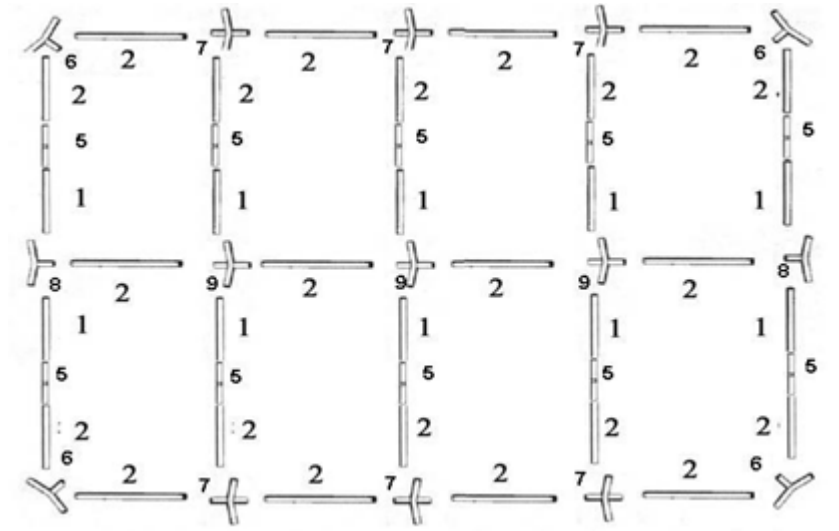

2. Forbind den ene ende af stængerne (3, 4) til samlerne (6, 7).

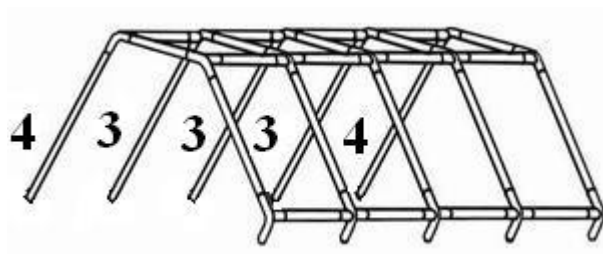

3. Læg tagdugen på rammen og fastgør med elastikker – pas på med at stramme elastikkerne for meget, da dette kan gøre det svært at tilpasse taget korrekt.

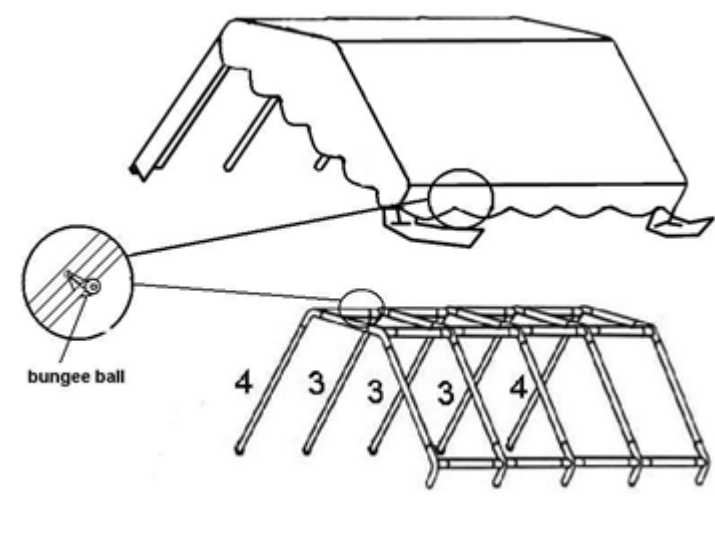

4. Sæt de resterende fire stænger (3, 4) fast til samlerne (6, 7) og rejs konstruktionen op. Sæt fødderne fast på benene og brug de lange pløkker til at fastgøre fødderne til jorden og sæt dugen fast til benene ved hjælp af krogene i stropperne.

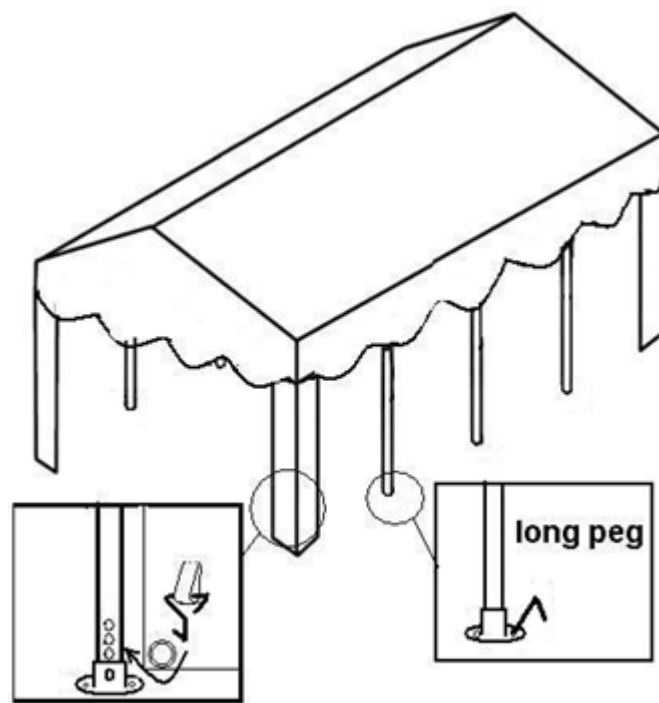

5. Fold sider og endegavle ud og sæt dem fast på rammen med elastikkerne. Sæt rammen fast i metaløjerne (Er placeret øverst på endegavle og sidepaneler) for størst mulig stabilitet. Brug også de korte pløkker til at fastgøre sider og gavle til jorden.

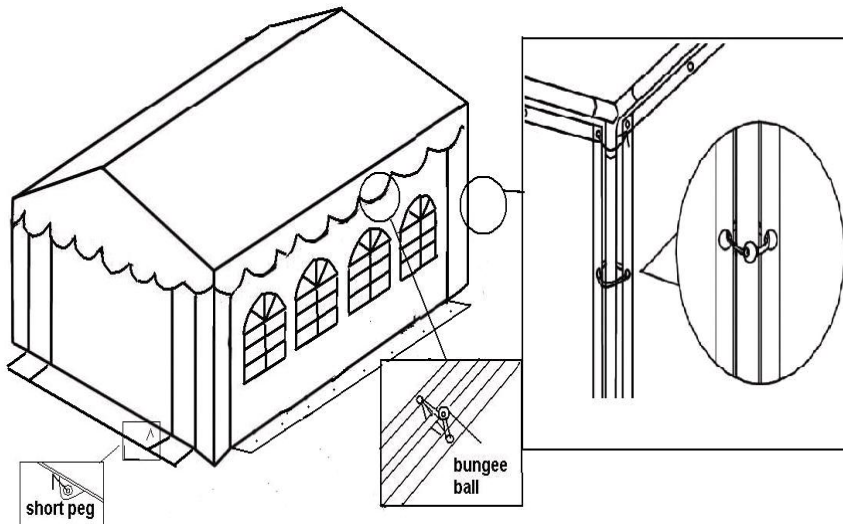

6. Sæt rebet i alle hjørner af teltet og fastgør med spiralpløkker.

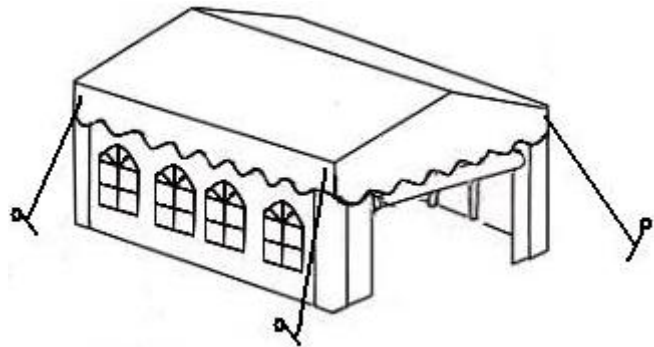



## Sikkerhedsadvarsler

- Vær altid forsigtig i håndteringen af teltet for at undgå at beskadige delene,
- Tving ikke rammen, da denne kan tage skade.
- Teltet er tiltænkt som en midlertidig indretning og skal tages ned i hårde vejrforhold.
- Vælg altid en egnet placering af teltet, så skader på sprinklersystemer og forsyningsledninger undgås.
- Selvom teltet er brandhæmmende, skal man være agtpågivende. Undgå åben ild og andre varmekilder.

## Bundramme til Partytelt

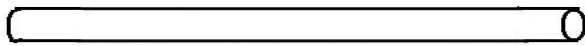
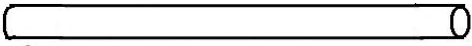
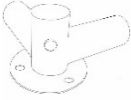
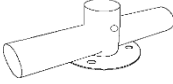
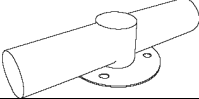
1. Følg anvisningerne til montering af partyteltet.
2. Forbind fødderne (12 & 13) til benene (3) som vist i illustrationen nedenfor – i stedet for stedet for standardsamlerne, som følger med til partyteltet. Brug bolte.
3. Når benene står rigtigt, isættes stængerne (1 & 2) i fødderne (12, 14 & 13).
4. Sidepaneler og gavlender skal sættes fast til stængerne (1, 2) med elastikker.

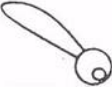
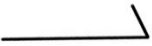
Position og antal		Beskrivelse
NO.1 x 8		Lang stang 1.940mm
NO.2 x 6		Kort stang 1.600mm
NO.12 x 4		Fod til hjørner
NO.13 x 6		Fod til sider
NO.14 x 4		Fod til gavlender
x 38		Bolt
x 36		Elastikker
x 36		Pløkker

**Obs. Alle illustrationer er vejledende og kan afvige fra det leverede produkt.**

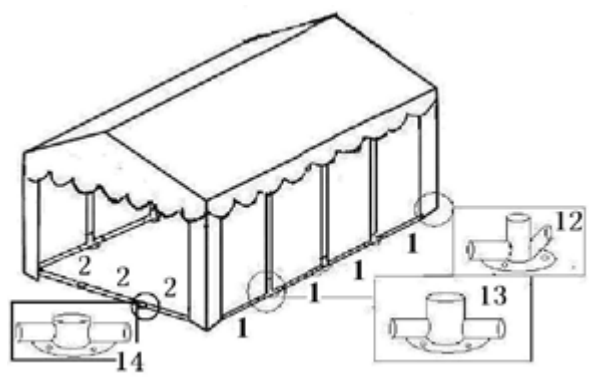

Vi forbeholder os ret til uden foregående varsel at ændre de tekniske parametre og specifikationer for dette produkt.



# S

## Original

### Bruksanvisning















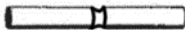



**Partytält 5 x 8 meter - 9035575**

**Bottenram till partytält 5 x 8 meter - 9046699**

**Partytält 5 x 8 meter - inkl. bottenram - 9035576**

#### Komponenter

	Beskrivning		Antal
1	Kort stång		10 st
2	Lang stång		22 st
3	Ben, mellan -u. fot		6 st
4	Ben, hörn -u. fot		4 st
5	Monteringsrör		10 st
6	Monteringsrör hörn/sida		4 st
7	Monteringsrör, mellan/sida		6 st
8	Monteringsrör, tak/gavel		2 st
9	Monteringsrör, tak/mellan		3 st
10	Fot		10 st

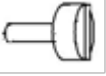
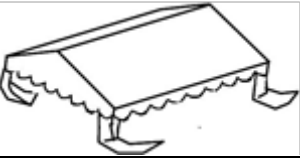
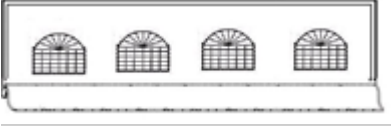
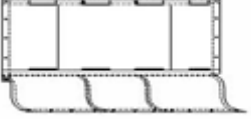
11	Rep		4 st
12	Spiral pinne		4 st
13	Lång pinne		10 st
14	Kort pinne		36 st
15	Elastiskt band med kula		22 st
16	Elastiskt band med kula		76 st
17	Skruv		74 st
18	Takduk		1 st
19	Sidopaneler		2 st
20	Endgavel		

## Montering

1. Välj att montera tältet på en plan yta. Packa upp tältet och kontrollera att alla delar är med. Montera taket med monteringsrören nr 6, 7, 8 och 9 med stängerna 1, 2 och 5. Kontroller att spännskruven är fast på alla stängerna.

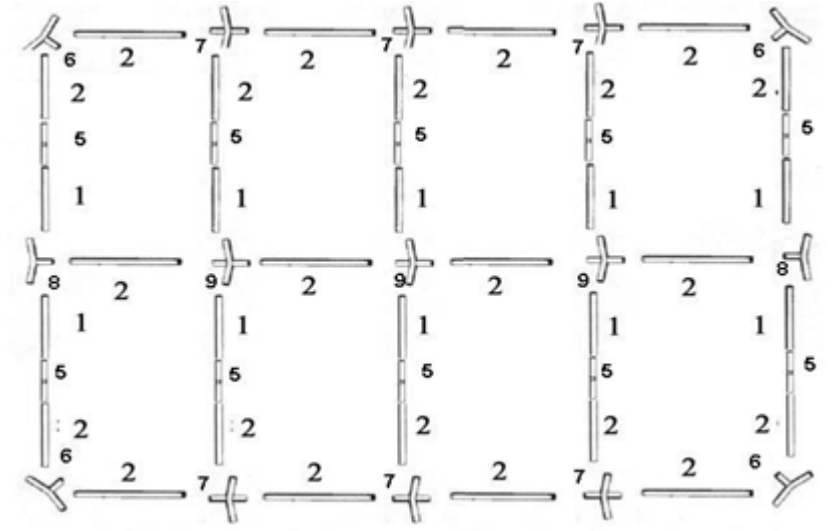

2. Montera den ena änden av stängerna (3, 4) till monteringsrören (6, 7).

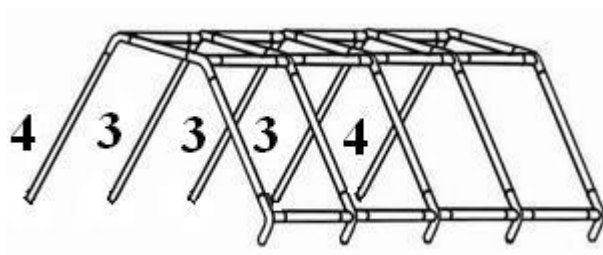

3. Lägg över takduken på ramen och fäst med gummiknopparna – Var uppmärksam på att inte stropparna är för strama, det kan göra att passformen inte blir korrekt.

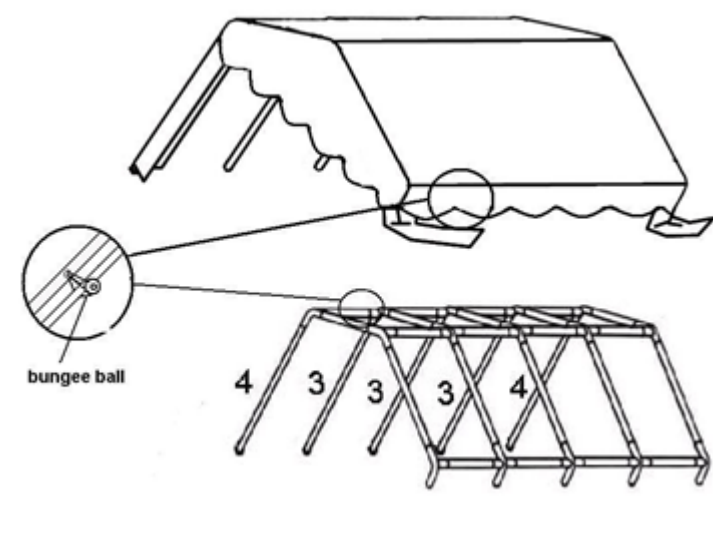

4. Montera de resterande fyra stängerna (3, 4) ihop med monteringsrören (6, 7), rest upp konstruktionen. Sätt fast fötterna på benen och använd de långa jordpinnarna för att fixera fötterna i marken. Montera duken vid benen med hjälp av krokarna.

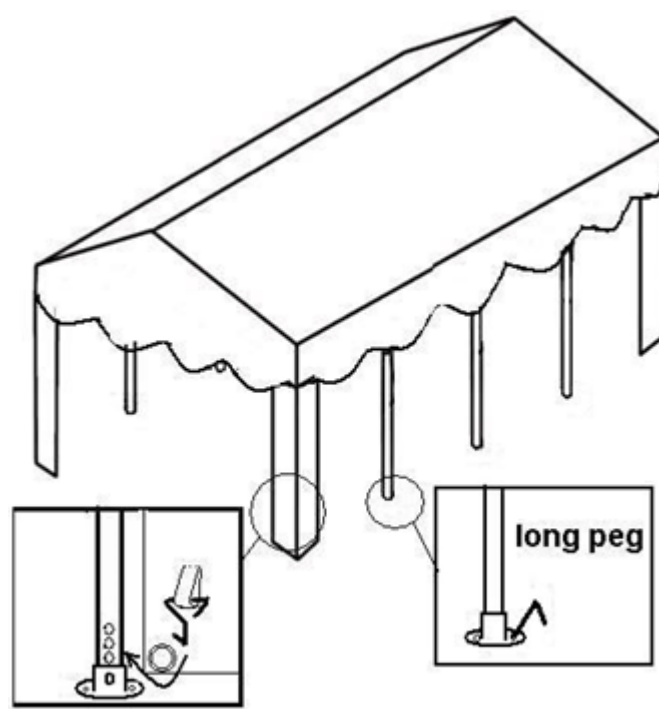

5. Veckla ut sidor och ändgavlar och montera dem på ramen med medföljande elastiska stroppar. Montera ramen i metallöglorna (är placerad överst på ändgavlarna och sidopanelerna) för stabilitet. Använd också de kortare pinnarna till att förankra sidorna och gavlarna till marken.

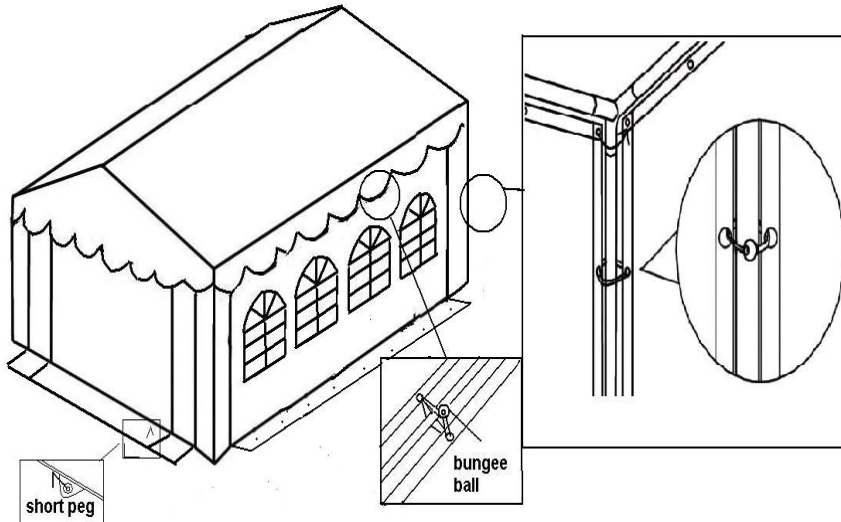

6. Montera repet på tältets alla hörn och förankra med jordpinnar.

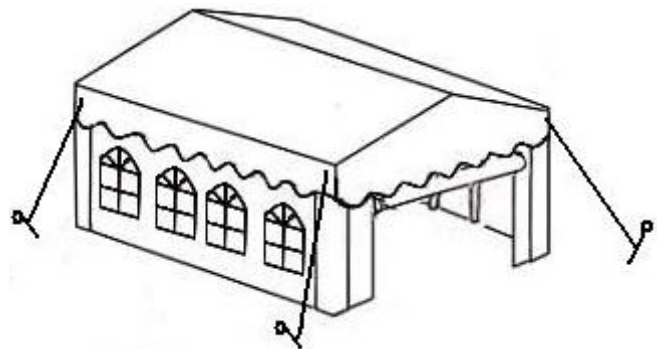



## Säkerhetsanvisningar

- Var alltid försiktig vid montering av tältet.
- Tvinga inte ramen i någon riktning, det kan skada den.
- Tältet är tänkt som en tillfällig inrättning, det ska plockas ned vid hårdare väderförhållanden.
- Välj alltid en plan yta för montering av tältet.
- Tältet är brandhämmande, undvik att elda med öppna låga eller använda andra värmekällor.

## Bottenram till partytält

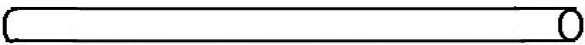
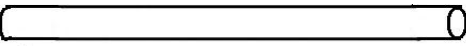
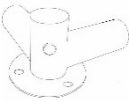
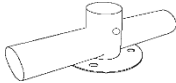
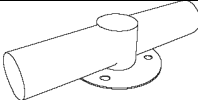
1. Följ anvisningarna montering av partytält.
2. Anslut fötterna (12 & 13) till benen (3) som illustrationen nedan visar – istället för monteringsrören som följer med tältet använd bultar.
3. När benen står riktigt sätt i stängerna (1 & 2) i fötterna (12,14 & 13).
4. Sidopanelerna och gavlarna ska monteras fast i stängerna (1, 2) med elastiska knoppar.

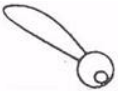
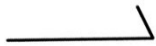
Position och antal		Beskrivning
NO.1 x 8		Lång stång 1940mm
NO.2 x 6		Kort stång 1600mm
NO.12 x 4		Fot till hörnen
NO.13 x 6		Fot till sidorna
NO.14 x 4		Fot till gavlarna
x 38		Bult
x 36		Elastiska knoppar
x 36		Pinnar

**Obs. Alla illustrationer är vägledande och kan avvika något från levererad produkt.**

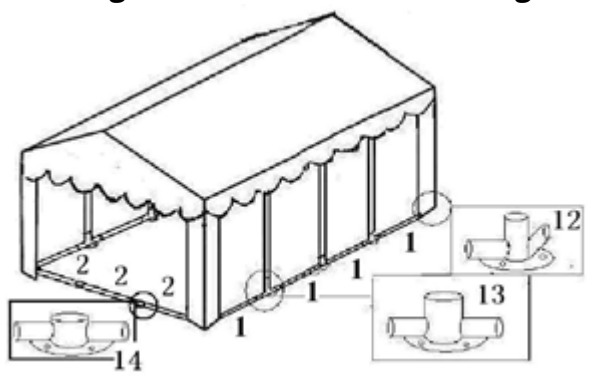









Vi förbehåller oss rätten att ändra tekniska parametrar och specifikationer för denna produkt utan föregående meddelande.





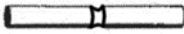

D  
Original  
Bedienungsanleitung



**Partyzelt 5 X 8 Meter - 9035575**  
**Grundrahmen für Partyzelt 5 X 8 Meter - 9046699**  
**Partyzelt 5 X 8 Meter - inkl. Grundrahmen 9035576**

**Komponenten**

	<b>Beschreibung</b>		<b>Anzahl</b>
1	Kurzer Stab		10 Stk.
2	Langer Stab		22 Stk.
3	Bein, Zwischenverb. und Fuß		6 Stk.
4	Bein, Ecke und Fuß		4 Stk.
5	Verbindungsrohr		10 Stk.
6	Verbindung, Ecke/Seite		4 Stk.
7	Verbindung, Zwischenverb. /Seite		6 Stk.
8	Verbindung, Dach/Giebel		2 Stk.
9	Verbindung, Dach/Zwischenverb.		3 Stk.

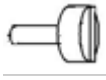
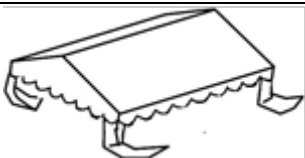
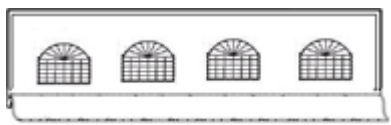
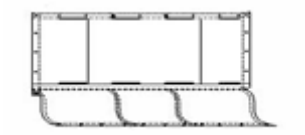
10	Fuß		10 Stk.
11	Seil		4 Stk.
12	Erdnagel mit Öse		4 Stk.
13	Erdnagel, lang		10 Stk.
14	Erdnagel, kurz		36 Stk.
15	Gummiband mit Kugel		22 Stk.
16	Gummiband mit Kugel		76 Stk.
17	Spannschraube		74 Stk.
18	Dachplane		1 Stk.
19	Seitenplane		2 Stk.
20	Endgiebel		



## Montage

1. Wählen Sie ein flaches Gelände. Packen Sie das Zelt aus und überprüfen Sie, ob alle Teile vorhanden sind. Bauen Sie das Zelt zusammen, indem die Verbindungen 6, 7, 8 und 9 mit den Stäben 1, 2 und 5 verbunden werden. Vergewissern Sie sich, dass die Spannschraube an jedem Stab fest angezogen ist.

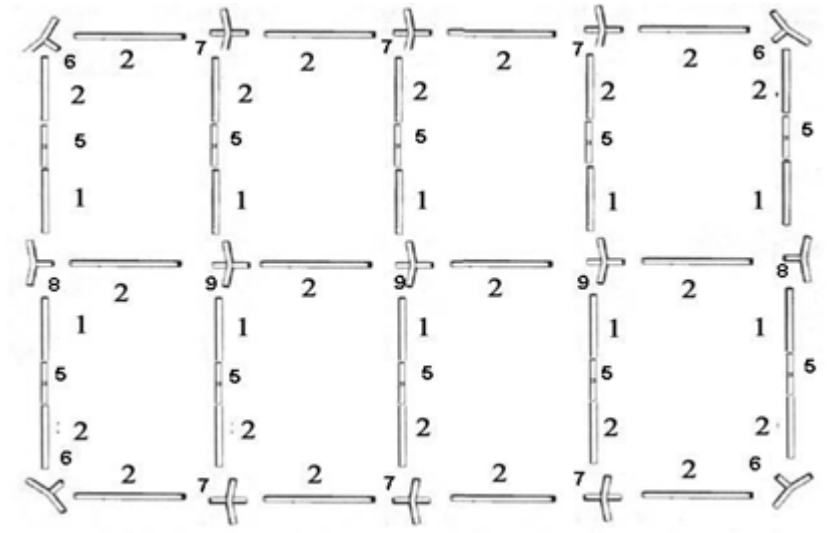

2. Verbinden Sie das eine Ende der Stäbe (3, 4) mit den Verbindern (6, 7).

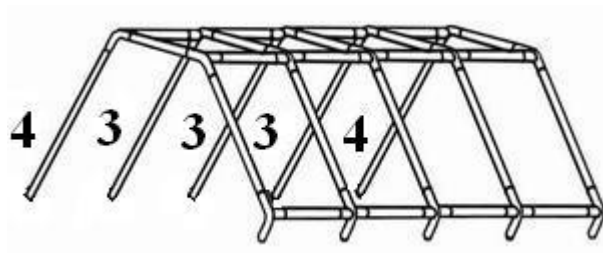

- Legen Sie die Zeltplane über den Rahmen und befestigen Sie diese mit den Gummibändern. Achten Sie beim Spannen der Gummibänder darauf, diese nicht zu fest anzuziehen, da das Dach ansonsten schwer ausgerichtet werden kann.

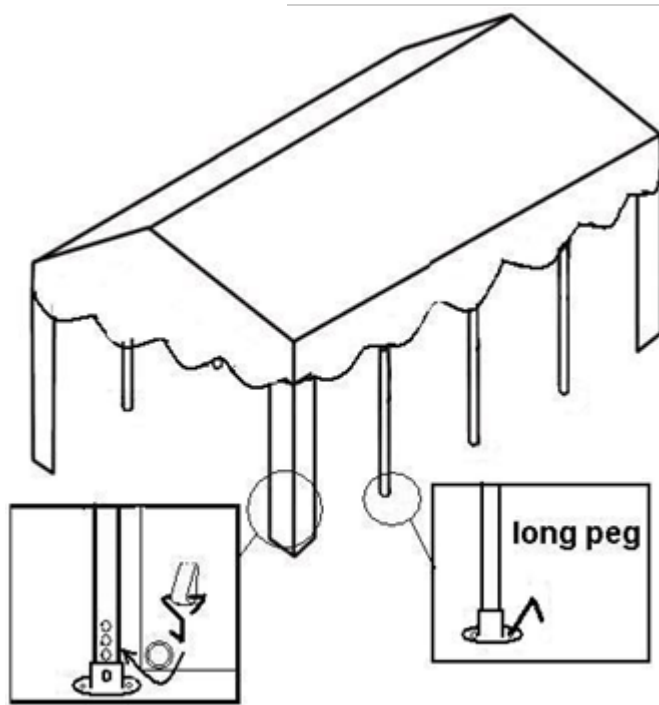
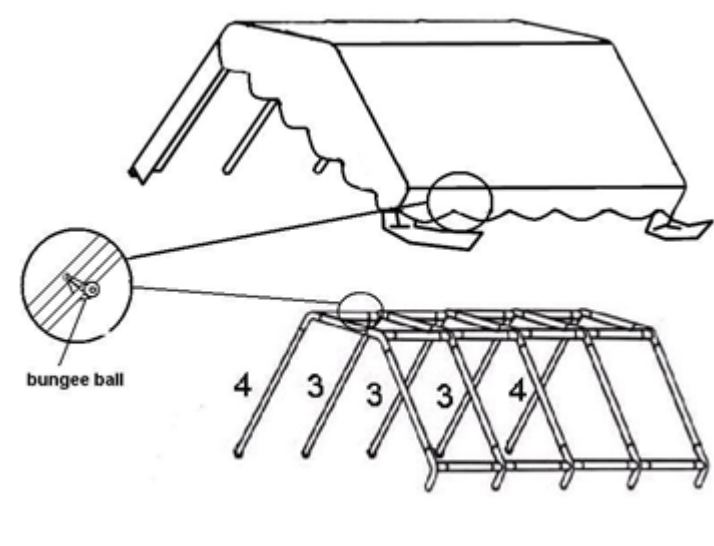

- Befestigen Sie die restlichen vier Stäbe (3, 4) an den Verbindern (6, 7) und stellen Sie die Konstruktion auf. Montieren Sie die FüÙe auf die Beinstützen und verwenden Sie die langen Erdnägel, um die FüÙe am Boden zu befestigen. Befestigen Sie dann die Plane mithilfe der Haken in den Riemen an den Beinen.

- Schlagen Sie Seiten und Endgiebel auseinander und befestigen Sie diese mit den Gummibändern am Rahmen. Um die beste Stabilität zu erlangen, befestigen Sie den Rahmen an den Metallaugen (befinden sich ganz oben am Endgiebel und an den Seitenplanen). Verwenden Sie auch die kurzen Erdnägel zur Befestigung der Seiten und des Giebels im Erdreich.

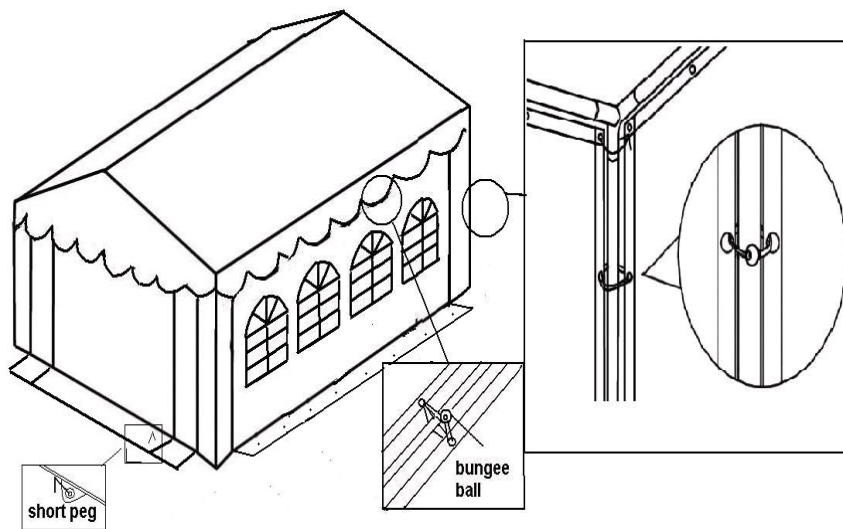

6. Montieren Sie das Seil an allen Zeltecken und befestigen Sie es mit den Erdnägeln mit Ösen.

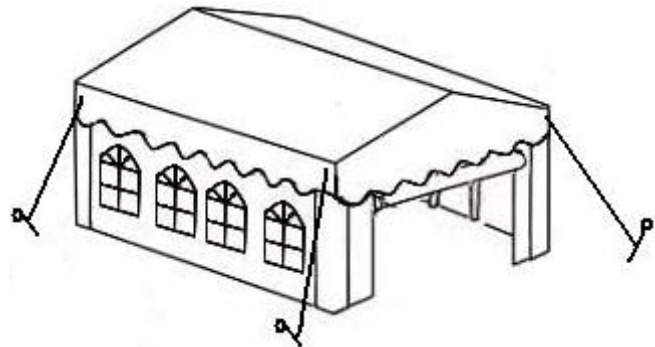



## Sicherheitshinweise

- Seien Sie im Umgang mit dem Zelt stets vorsichtig, damit die Teile nicht beschädigt werden.
- Stecken Sie den Rahmen nicht gewaltsam zusammen, da er dadurch beschädigt werden kann.
- Das Zelt ist als Übergangslösung gedacht und muss bei schlechter Witterung abgebaut werden.
- Wählen Sie stets einen geeigneten Platz zum Aufstellen des Zeltes, um Schäden an Sprinklersystemen und Versorgungsleitungen zu vermeiden.
- Das Zelt ist zwar feuerhemmend, seien Sie aber trotzdem sehr vorsichtig. Offenes Feuer und andere Wärmequellen sind zu meiden.

## Grundrahmen für Partyzelt

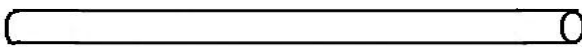
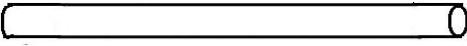
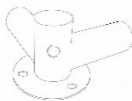
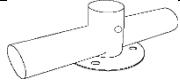
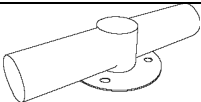
1. Befolgen Sie die Anweisungen für die Montage des Partyzelts.
2. Verbinden Sie die Füße (12 & 13) wie in der Abbildung unten gezeigt mit den Beinen (3), und zwar anstatt der Standardverbinder, die mit dem Partyzelt geliefert werden. Verwenden Sie Schrauben.
3. Wenn die Beine richtig stehen, werden die Stäbe (1 & 2) an den Füßen (12, 14 & 13) montiert.
4. Die Seitenplanen und Giebelenden müssen mit Gummibändern an den Stäben (1, 2) befestigt werden.

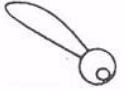
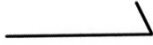
Position und Anzahl		Beschreibung
NO.1 x 8		Langer Stab 1940mm
NO.2 x 6		Kurzer Stab 1600mm
NO.12 x 4		Fuß für Ecken
NO.13 x 6		Fuß für Seiten
NO.14 x 4		Fuß für Giebelenden
x 38		Bolzen
x 36		Gummibänder
x 36		Erdnägel

**Achtung! Bei allen Abbildungen handelt es sich um Beispielfotos, das jeweilige Produkt kann abweichen.**

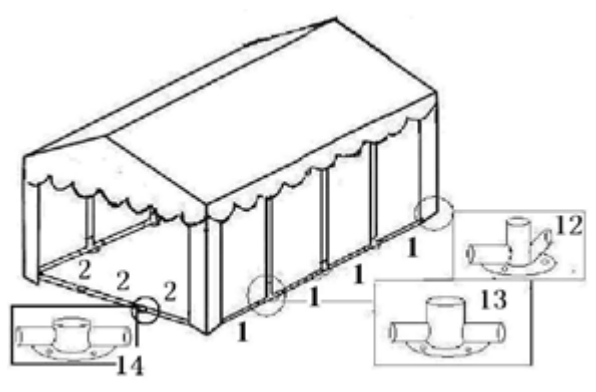

Wir behalten uns das Recht vor, ohne vorherige Information technische Parameter oder Spezifikationen für dieses Produkt zu ändern.

GB  
Original  
Assembly Instructions











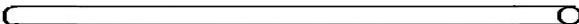

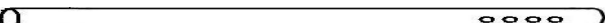

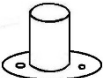

**Party tent 5 x 8 meter - 9035575**

**Ground Bar for party tent 5 x 8 meter - 9046699**

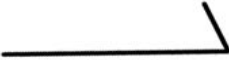
**Party tent 5 x 8 meter - incl. ground bar - 9035576**

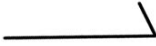
**Components**

1.	Frame Pole		<b>10</b>
2.	Frame Pole		<b>22</b>
3.	Support Pole		<b>6</b>
4.	Support Pole		<b>4</b>
5.	2 Way Connector		<b>10</b>
6.	110° 3 way Connector		<b>4</b>
7.	110° 4 way Connector		<b>6</b>
8.	140° 3 way Connector		<b>2</b>
9.	140° 4 way Connector		<b>3</b>
10.	Foot stand		<b>10</b>
11.	Guy ropes		<b>4</b>
12.	Spiral peg		<b>4</b>
13.	Long Peg		<b>10</b>

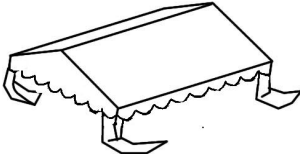
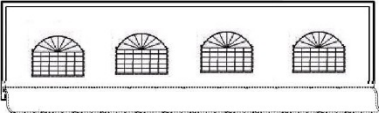
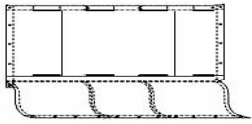
14.	Short Peg		36
15.	Bungee Ball		22
16.	Bungee Ball		76
17.	Screw		74
18.	Canopy		1
19.	Sidewalls		2
20.	End walls		2

## Assembly

### I

Select an area of flat ground for the tent. Unpack the carton and check all parts including tubes, tent and accessories... etc. are present. Assemble the rooftop framework by joining the (6,7,8,9) Connectors together with poles (1,2,5). Ensure the tension screw is fixed to every pole tightly.

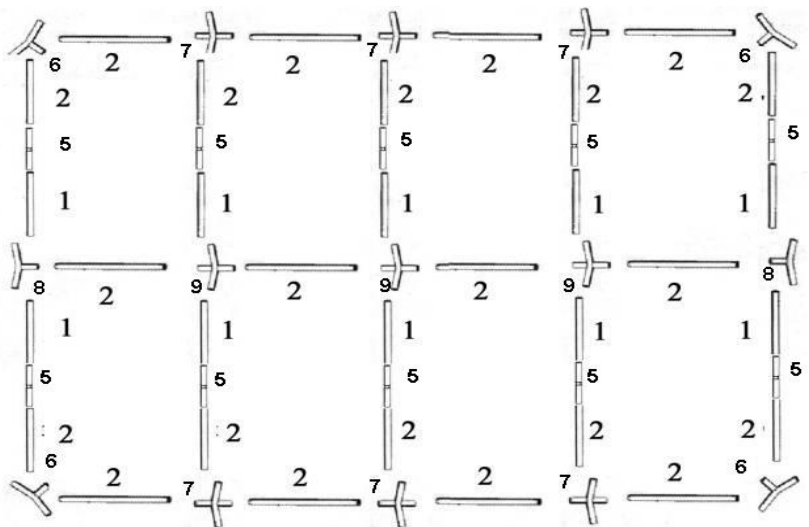

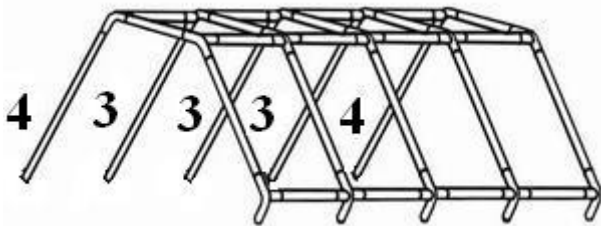

**II** Attach one end of the support poles (3,4) to the roof joints (6,7).

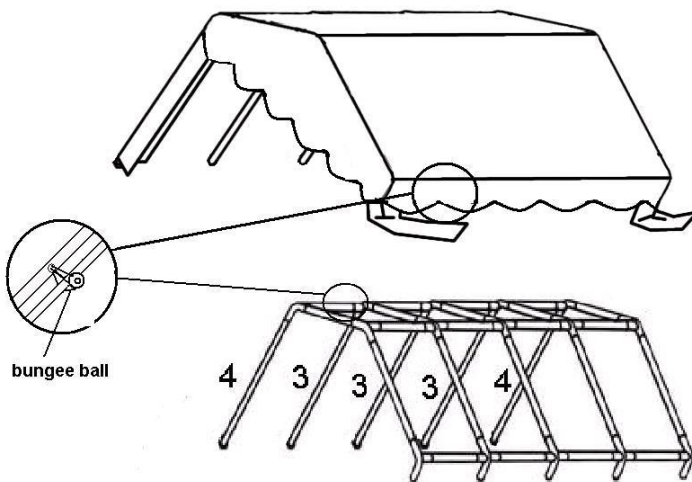

**III** Place canopy on frame, and attach with bungee fixings, take care not to over tension bungee, as this may cause difficulty correctly fitting roof.

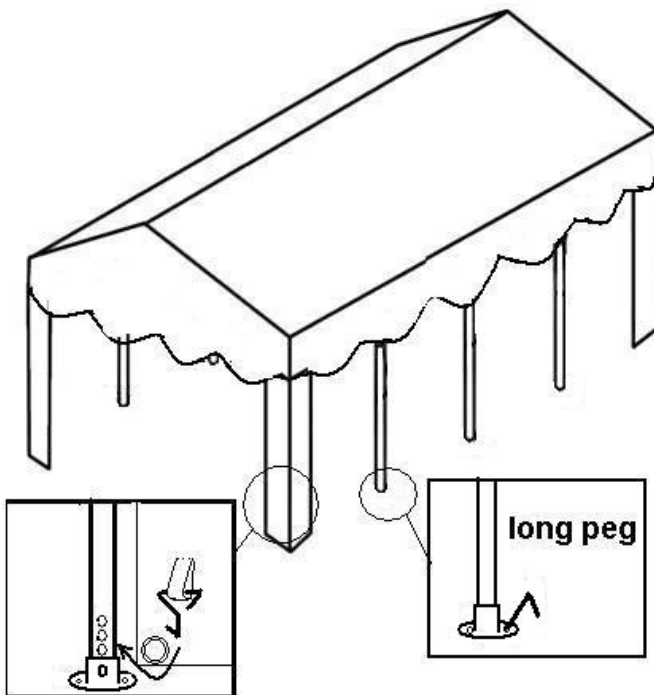

**VI** Attach the other 4 supporting poles (3,4) to the joints (6,7), build-up the framework . Fasten foot stand with legs and then use the long peg to fix each pole into the ground and use the hook to fix the leg cover to the leg.



**V** Spread the wall and door panels, and attach to framework using the bungee cords. Clasp the frame to the metal eyelets (located over the wall and door panels) to ensure stability. Also use the short pegs to fix the doors and walls to the ground.

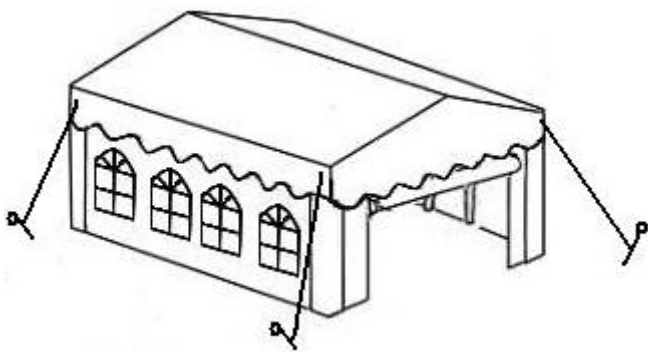
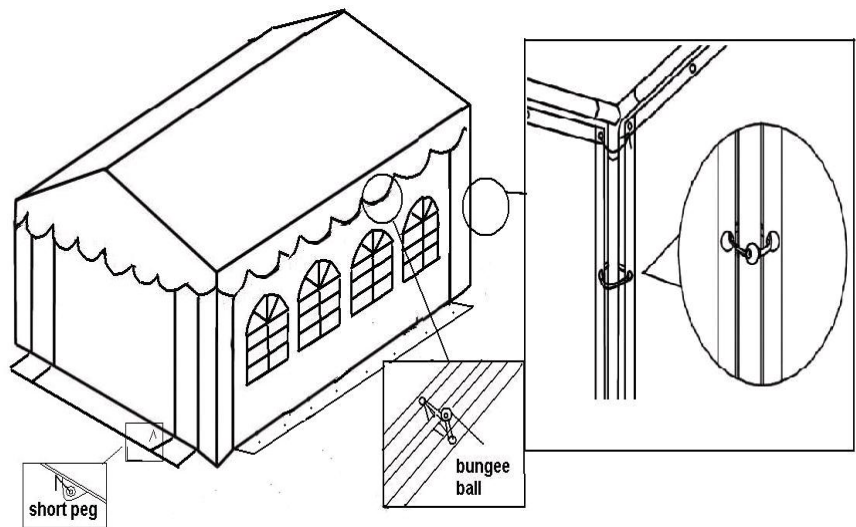

**VI** Attach Guy ropes to all corners of tent and fix to ground using ground pegs.





## **Warning**

1. Take note that the tent needs to be handled carefully to avoid damage.
2. Do not force the frame, as there may be damage in the process.
3. Tents are meant as temporary shelter and must be evacuated under extreme weather conditions.
4. Please select a suitable site for the tent to avoid damage to underground sprinkler systems, water, gas or electrical lines.
5. Whilst this product is Fire retardant care should be taken. Keep away from naked flame and other heat sources.

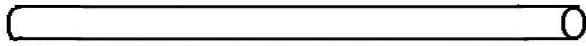
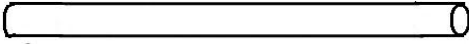
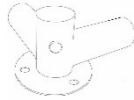

### 5X8 GROUND BAR INSTRUCTION

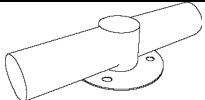
1. Follow Assembly Instructions for your Party Tent.
2. Attach base plates (12&13) to legs (3) (Fig.4), in place of standard base plates (NO.10) supplied with your Party tent, using bolts.
3. When the legs are in position insert ground bars (1&2) into base plates (12.14.13)
4. Side and End Walls will need to be attached to ground bars (1, 2) with bungees.

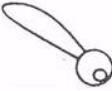
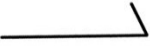
NO.1 X 8		Ground Bar 1940mm
NO.2 X 6		Ground Bar 1600mm
NO.12X 4		Ground Bar Corner Base Plate
NO.13X 6		Ground Bar Gable End Base Plate
NO.14X 4		Ground Bar Side Base Plate
BT X 38		Bolt
BG X 36		Bungees
P X 36		Pegs

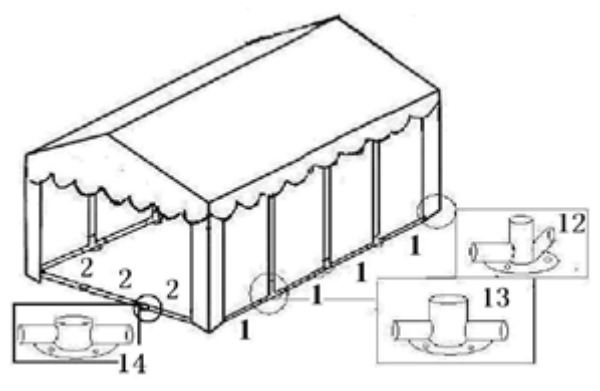

**All images used are for illustration purposes only and may not represent an individual product.**

We reserve the right to change the technical parameters and specifications of this product without prior notice.