

Original Manual

9064333, 9064334 & 9064335

DK/N: Styreskinner til savværk

S: Styrskena till sågverk

D: Führungsschiene für Sägewerk

GB: Guide rail for sawmill

213 cm

243 cm

274 cm



DK

S

D

GB

DK Original Brugsanvisning

Styreskinne 213 cm - artikelnr. 9064333

Styreskinne 243 cm - artikelnr. 9064334

Styreskinne 274 cm - artikelnr. 9064335

Beskrivelse: Letvægts styreskinner til savværk, fremstillet i aluminium. Skinnerne fås i tre længder, og kan forlænges ved hjælp af en samler. Når du bruger en styreskinne sammen med dit savværk, bliver det første snit meget præcist, hvilket sikrer at de efterfølgende planker bliver skåret med samme præcision, da skinnen markerer anslaget til det næste bræt. Alle skinnerne kan kombineres og forlænges, så har du behov for en styreskinne på f.eks. 5 meter, kan du forlænge en skinne på 8 fod med en skinne på 9 fod for at få den ønskede længde. Du kan vælge mellem tre længder af skinner.









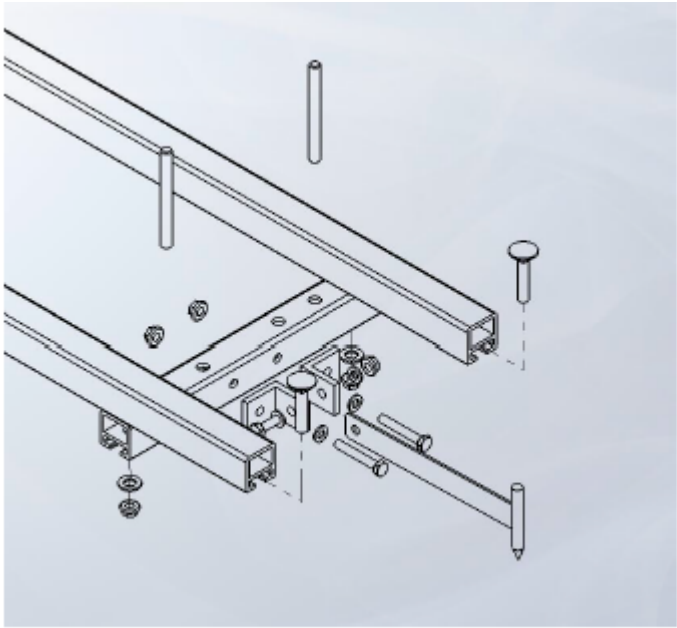
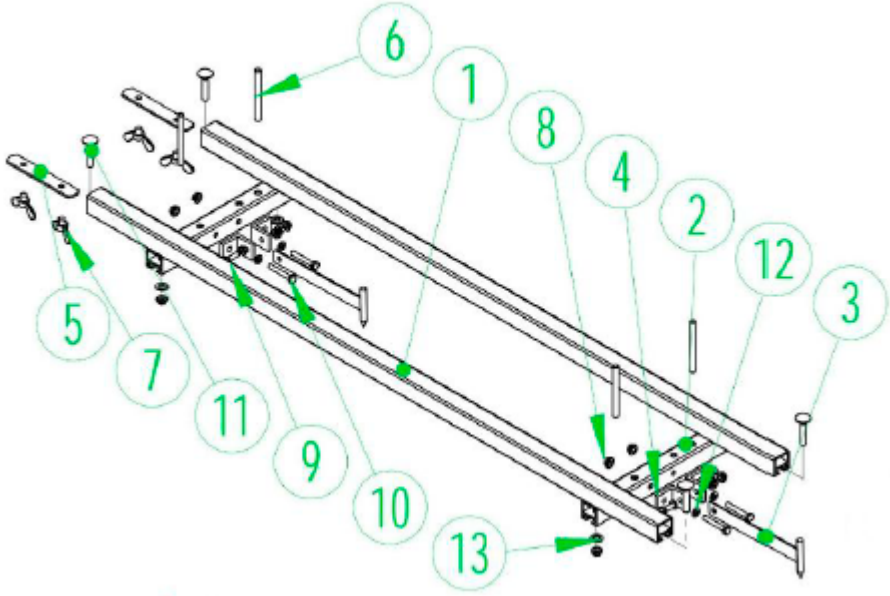



Tilsigtet anvendelse: Udstyret må kun anvendes som beskrevet i denne brugsanvisning, al anden anvendelse betragtes som forkert.

Indhold

Splittegning og komponentliste.....	2
Monteringsvejledning	4

Splittegning og komponentliste



Nr.	Antal	Foto	Beskrivelse
1	4		Sideskinne
2	4		Tværstang
3	4		Holdejern
4	8		Beslag til holdejern
5	2		Forbindelsesstang
6	8		Nivelleringskrue
7	4		Fingerskrue
8	12		Lille møtrik
9	4		Tværbolt
10	8		Lang bolt
11	8		Bræddebolt
12	24		Lille spændeskive
13	8		Stor spændeskive
14	8		Stor møtrik

Monteringsvejledning

1. Pak styreskinnen ud og læg alle dele ud og sorter dem.
2. Sæt to beslag til holdejern (4) til tværstangen (2), med bolte, spændeskiver og møtrikker (10, 12 og 8). Spænd dem ikke før holdejernet er monteret.



3. Forbind holdejern (3) til beslagene (4) med bolt, spændeskive og møtrik (9, 12, 8). Spænd alle bolte.



4. Monter bræddebolte (11), møtrikker og spændeskiver (14 og 13) gennem tværstangen (2), spænd ikke endnu. Hovedet på bræddebolten skal være som vist.



5. Installer nivelleringskruer (6) i tværstangen (2). Skruernes skårne ende skal have samme retning som bræddeboltens hoved.
6. Gentag for alle tværstænger.
7. Skub bræddeboltene i tværstængerne ind i skinnerne. Spænd ikke før EZ-skinnerne er sat på stammen. Holdejernene kan vende i begge retninger.
8. Når tværstangen er sat på stammen, spændes bræddeboltene.
9. For at forlænge skinnerne, brug da 2 stk. forbindelsesstænger (5) og hver ende fastgøres med fingerskrue (7).



Vi forbeholder os ret til uden forudgående varsel at ændre de tekniske parametre og specifikationer for dette produkt.

S

Original

Bruksanvisning

Styrskena 213 cm - art. 9064333

Styrskena 243 cm - art. 9064334

Styrskena 274 cm - art. 9064335

Beskrivning: En lättviktsskena för sågverk, tillverkat i aluminium. Skenan finns i olika längder som kan kopplas ihop med varandra med en montage del som köps separat. När du använder en styrskena tillsammans med ditt sågverk blir första snittet exakt där du önskar det, efterföljande plankor blir även den precis, skenan markerar anslaget till nästa bräda. Alla skenorna kan kombineras och förlängas till den längd som du önskar.









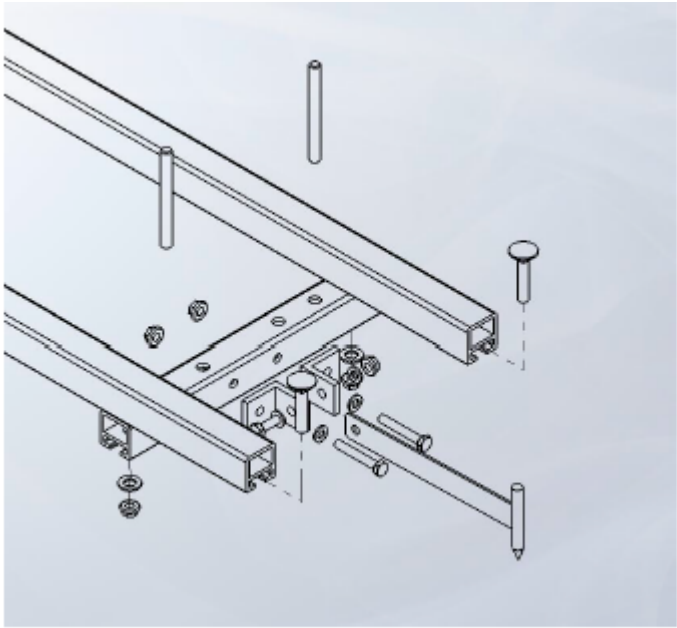
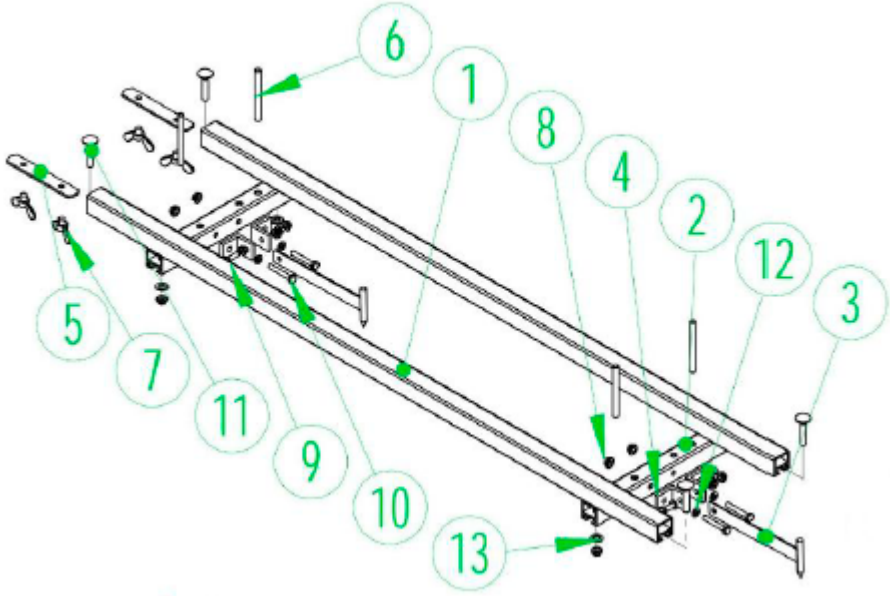





Avsedd användning: Får bara användas som bruksanvisningen anger – all annan användning anses som felaktig.

Innehåll

Sprängskiss och komponentlista.....	2
Monteringsanvisning.....	4

Sprängskiss och komponentlista



Nr.	Antal	Foto	Beskrivning
1	4		Sidoskena
2	4		Tvärstång
3	4		Fästjärn
4	8		Fäste för Fästjärn
5	2		Vevstake
6	8		Nivåskruv
7	4		Fingerskruv
8	12		Liten mutter
9	4		Korsbult
10	8		Lång bult
11	8		Brädbult
12	24		Liten bricka
13	8		Stor bricka
14	8		Stor mutter

Monteringsanvisning

1. Packa upp styrskenan och lossa alla delar och sortera dem.
2. Fäst två fästen (4) på tvärstången (2) med bultar, brickor och muttrar (10, 12 och 8). Dra inte åt dem förrän fästjärnet är monterat.



3. Anslut fästjärnet (3) till fästena (4) med bulten, brickan och muttern (9, 12, 8). Dra åt alla bultar.



4. Sätt in brädbultar (11), muttrar och brickor (14 och 13) genom tvärstången (2), dra inte åt ännu. Brädbultens huvud ska vara som visat.



5. Montera nivåskruvarna (6) i tvärstången (2). Skruvarnas kapade ände måste ha samma riktning som brädbultarna.
6. Upprepa för alla tvärstänger.
7. Skjut brädbultarna i tvärstångerna in i skenorna. Dra inte åt förrän EZ-skenorna är monterade i stocken. Fästjärnen kan vända i båda riktningar.
8. När tvärstången är fäst i stocken, dra åt brädbultarna.
9. För att förlänga skenorna, använd 2 st. vevstänger (5) som i varje ände är fästa med tumskruv (7).



D

Original

Betriebsanweisung

Führungsschiene 213 cm - Artikelnr. 9064333

Führungsschiene 243 cm - Artikelnr. 9064334

Führungsschiene 274 cm - Artikelnr. 9064335

Beschreibung: Leichte Führungsschienen für Sägewerke aus Aluminium. Die Schienen sind in drei Längen erhältlich und können mit einem Sammler verlängert werden. Wenn Sie mit Ihrem Sägewerk eine Führungsschiene verwenden, ist der erste Schnitt sehr präzise, wodurch sichergestellt wird, dass die nachfolgenden Dielen mit der gleichen Präzision geschnitten werden, da die Schiene den Anschlag für das nächste Brett markiert. Alle Schienen können kombiniert und verlängert werden, falls Sie eine Führungsschiene von z.B. 5 Meter brauchen, können Sie eine 8-Fuß-Schiene mit einer 9-Fuß-Schiene verlängern, um die gewünschte Länge zu erhalten. Sie können zwischen drei Schienenlängen wählen.









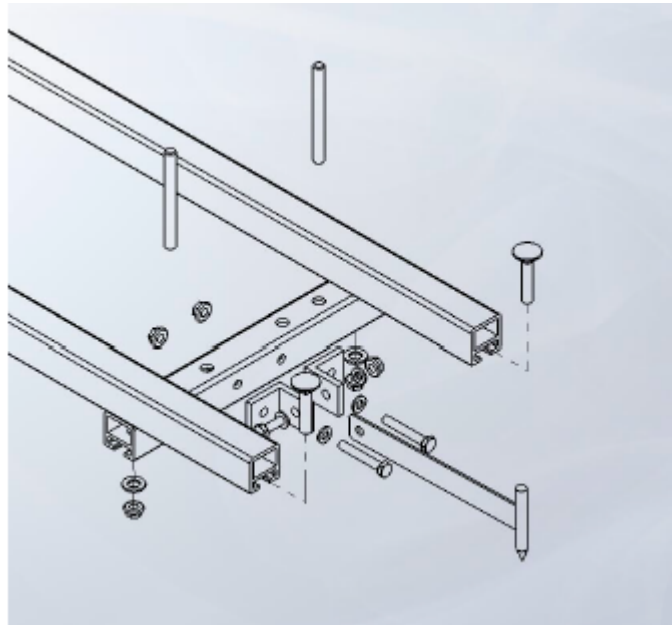
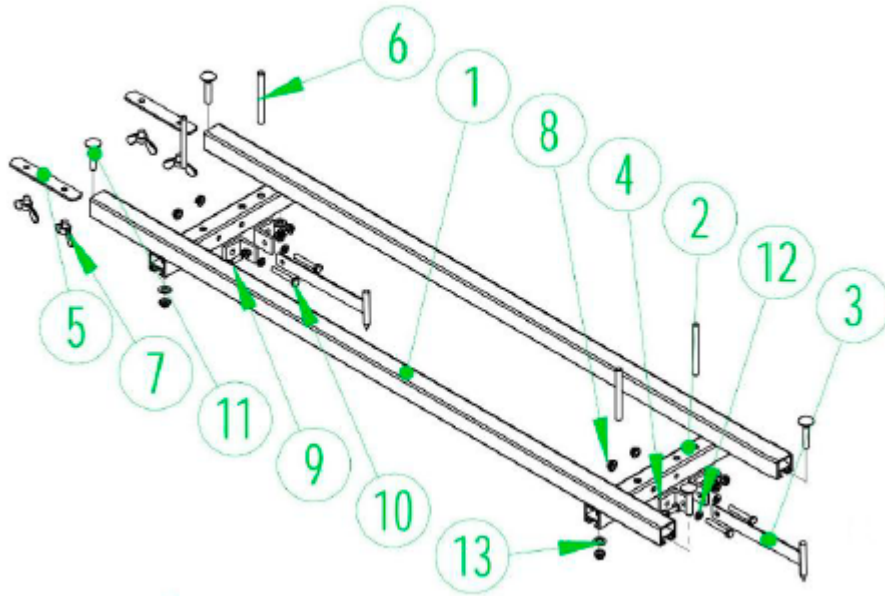





Bestimmungsgemäße Verwendung: Das Gerät darf nur wie in dieser Betriebsanweisung beschrieben verwendet werden. Alle anderen Verwendungszwecke gelten als falsch.

Inhalt

Explosionszeichnung und Komponentliste.....	2
Montageanleitung.....	4

Explosionszeichnung und Komponententliste



Nr.	Anzahl	Foto	Beschreibung
1	4		Seitenschiene
2	4		Querstange
3	4		Klammerhaken
4	8		Beschlag für Klammerhaken
5	2		Verbindungsstange
6	8		Nivellierschraube
7	4		Fingerschraube
8	12		Kleine Mutter
9	4		Querbolzen
10	8		Langer Bolzen
11	8		Bolzen mit rundem Kopf
12	24		Kleine Unterlegscheibe
13	8		Große Unterlegsscheibe
14	8		Große Mutter

Montageanleitung

1. Packen Sie die Führungsschiene aus, legen Sie alle Teile aus und sortieren Sie diese.
2. Setzen Sie zwei Beschläge für Klammerhaken (4) an die Querstange (2), mit Bolzen, Unterlegscheiben und Muttern (10, 12 og 8). Nicht festmachen bevor der Klammerhaken montiert ist.



3. Klammerhaken (3) mit den Beschlägen (4) mit Bolzen, Unterlegscheibe und Mutter (9, 12, 8). Alle Bolzen festziehen.



4. Bolzen mit runden Kopf (11), Mutter und Unterlegsscheiben (14 und 13) durch die Querstange (2) montieren, noch nicht festziehen. Der Kopf des Bolzens mit runden Kopf muss wie gezeigt sein.



5. Nivelierschraube (6) in der Querstange (2) installieren. Die Schraubenenden müssen in die selbe Richtung wie der Bolzen mit runden Kopf zeigen.
6. Wiederholen Sie das für alle Querstangen.
7. Schieben Sie die Bolzen mit runden Kopf in den Querstangen in die Schienen. Nicht bevor die EZ-Schienen in den Baumstamm gesetzt sind anziehen. Der Klammerhaken kann in beiden Richtungen zeigen.
8. Wenn die Querstange in den Baumstamm gesetzt wurde, werden die Bolzen mit den runden Kopf angezogen.
9. Um die Schiene zu verlängern, verwenden Sie zwei Verbindungsstangen (5) und jedes Ende wird mit einer Fingerschraube (7) befestigt.



Wir behalten uns das Recht vor, ohne vorherige Ankündigung, die technischen Parameter und Spezifikationen für dieses Produkt zu ändern.

GB Original Manual

Guide rail 213 cm - artikelnr. 9064333

Guide rail 243 cm - artikelnr. 9064334

Guide rail 274 cm - artikelnr. 9064335

Description: Lightweight guide rails for sawmills, made of aluminum. The rails are available in three lengths and can be extended using a collector. When you use a guide rail with your sawmill, the first cut is very precise, which ensures that the subsequent planks are cut with the same precision, as the rail marks the stop for the next board. All the rails can be combined and extended, so if you need a guide rail of e.g. 5 meters, you can extend an 8-foot rail with a 9-foot rail to get the desired length. You can choose from three lengths of rails.









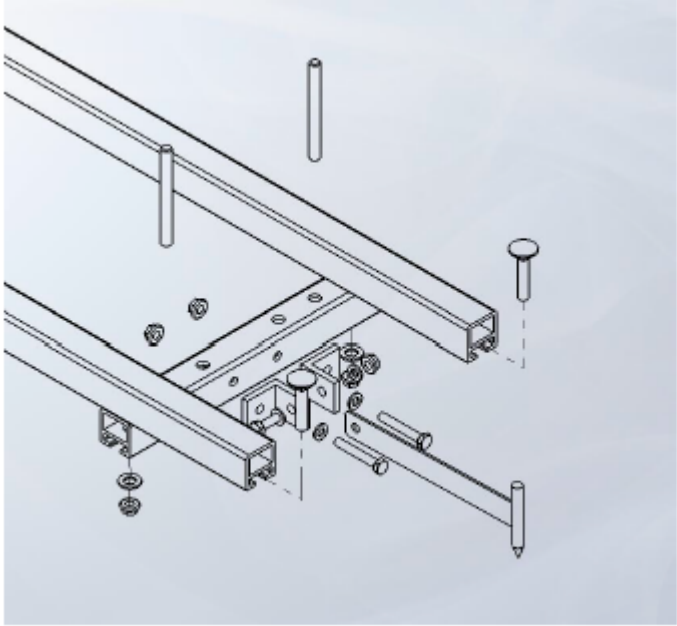
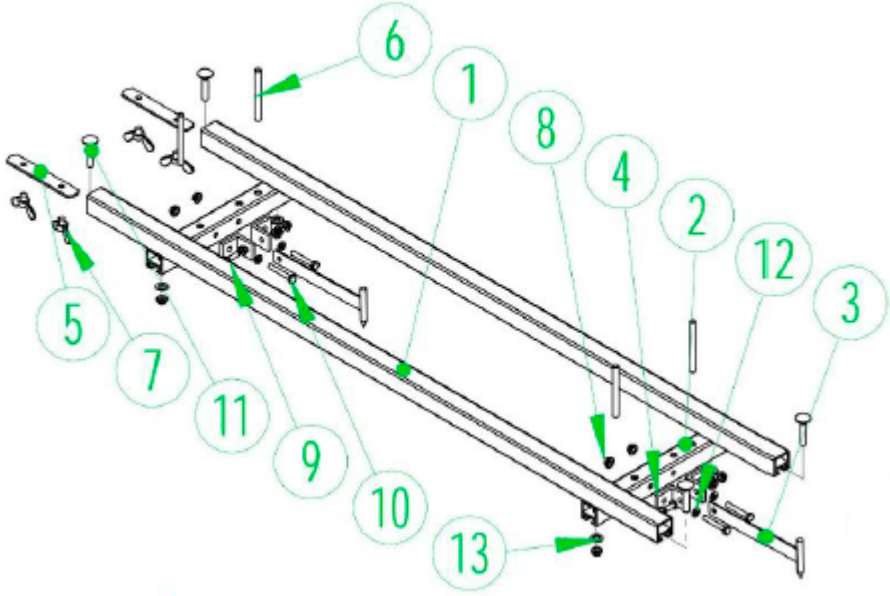





Intended use: The equipment may only be used as described in these operating instructions, all other use is considered incorrect.

Content

Drawing and parts list.....	2
Assembly instruction.....	4

Drawing and parts list



NO	QTY (Length> 3ft)	PICTURE	DESCRIPTION
1	4		Side rail
2	4		Cross bar
3	4		Dog
4	8		Dog hinge plate
5	2		Connect bar
6	8		Leveling screw
7	4		Butterfly screw
8	12		Small nut
9	4		Cross bolt
10	8		Long bolt
11	8		Carriage bolt
12	24		Small Washer
13	8		Large Washer
14	8		Large nut

Assembly instruction

1. Unpack the rail kit and lay out all parts and sort them.
2. Attach both dog hinges plats (4) to the cross bar (2) with bolts, washers and nuts. (10, 12 og 8). Do not tighten until dog is attached.



3. Attach dog (3) to hinge plates (4) with bolt, washers and nut (9, 12, 8). Tighten all bolts.



4. Assemble carriage bolts (11), nuts and washer (14 and 13) through cross bar (2), leave loose. Head of carriage bolt must be as shown.



5. Install leveling screws (6) into cross bar (2). Slotted end of screws is in same direction as the head of the carriage bolts.
6. Repeat for all cross bar kits.
7. Slide carriage bolts in cross bar into rails. Do not tighten until you set up the EZ-rails on the log. Dog orientation can be in either direction.
8. Once cross bars are located on the log, tighten the carriage bolts.
9. To extend the rail to longer version, please use 2 connect bars (5) and each end fastened with a butterfly screw (7).



We reserve the right to change the technical parameters and specifications of this product without prior notice.